



**I N S T I T U T
D'É C O N O M I E
I N D U S T R I E L L E**

"Economic analysis of the effects of the expiry of the EU milk quota system"

Contract 30-C3-0144181/00-30

FINAL REPORT

Scientific Responsible: Vincent Réquillart

Experts involved: Zohra Bouamra-Mechemache and Roel Jongeneel

Research Assistant: Charlotte Penel

March 2008

Executive Summary

This report has been prepared to provide a quantitative assessment of the impact of the abolition of EU milk quotas on the EU dairy sector, including the different policy approaches of gradual phasing out and abrupt abolition of milk quotas.

Background on the modelling framework

This study relies on the integrated use of a model which takes into account the whole dairy chain, starting upstream from primary milk production and ending downstream with consumer demand for processed dairy products. At the primary supply level the model takes into account that milk is produced using a dairy cow herd, (compound) feed and roughage feed, among which grass from pasture land. The primary supply model also recognizes that milk and beef might be jointly produced and also takes into account beef output. The supply model also takes overtime improvements in milk yields into account. On average over the period 2008-2020, milk yields (autonomously) increase by 1.03% and 1.21% per annum for the EU15 and EU10 respectively. These yield increases, which vary over countries, are based on empirical estimates. As regards the policy side, the milk quota policy is taken into account with respect to national quota levels and fat correction to deal with actual fat composition of milk. In case of binding milk quota this implies that an estimate of the value of the quota rent has to be used (see more detailed discussion below). Also the direct payments received by dairy producers, which are considered to be fully decoupled, are accounted for.

To deal with the downstream part of the dairy chain, a processing model is used which accounts for the processing of raw milk into fourteen final dairy products, thereby taking into account that milk and milk products consist of fat and protein and that balances for these components should hold. Distinguished products are Butter, Skim Milk Powder, Whole Milk Powder, Casein, Condensed milk, Liquid milk, Cream, Fresh products, and six categories of cheese: Fresh cheese, Semi hard cheese, Hard cheese, Blue cheese, Soft cheese and Processed cheese.

The demand for final products is modelled for the EU as well as for the rest of the world. As regards the rest of the world four net importing regions are distinguished: CIS (Commonwealth of Independent States) and the rest of Europe (including Turkey), Asia, Africa and Middle East countries, and America. The estimated demands for milk products in the EU and rest of the world (RoW) taking into account autonomous shifts in demand are based on previous empirical estimation work. Over the period from 2008 to 2015, at the EU25 level, the annual increase in fat and protein demand is respectively 0.1% and 0.5%. The demand for imports in the RoW is assumed to increase by 2 to 3% per year depending of the products. In addition to the 4 importing zones, the model also includes a net exporting zone: Oceania. The net supply of dairy products from New Zealand and Australia is modelled. Then dairy products from Oceania are competing with EU exports to fulfil the demand from the 4 importing zones.

In addition to the already mentioned milk quota instrument and direct payments, which hold at the primary sector level, the policy instruments considered with respect to the final products are price support measures as well as border measures. Price support includes: minimum prices for Skimmed

Milk Powder (SMP) and butter, consumption subsidies for SMP and butter, and production subsidies for casein. Border measures consist of import duties (for the EU as well as importing areas), tariff rate quotas (TRQs), and export refunds (including the WTO commitments on the volume and the value of subsidized exports).

Focusing on the EU, the geographical coverage of the model is the EU27, where the level of detail varies over the EU15, EU10 (new member states that joined the EU in 2004) and the EU2 (Bulgaria and Romania, which entered the EU in 2007). Except for Luxemburg (which is included in Belgium), all EU15 member states are represented at individual level. As regards the EU10 Poland, Hungary and Czech Republic are represented at individual member state level, whereas the remaining 7 countries are presented at an aggregate level (EU7).

Quota rent estimation and assumptions

Milk and dairy products markets are strongly influenced by the quota system. By restricting milk production, the quota system is a way to sustain prices. The key question we have to solve here is thus how the milk production in the different countries will vary if quotas are removed or expanded and what will be the price effects. As is explained in the report a key issue in this respect is the initial height of the quota rents, or its mirror side, the marginal costs of milk production. The marginal costs are estimated using the following synthetic 'estimation' procedure.

First, empirically estimated marginal costs are available for the year 2000 and with different length-of-runs. Because the focus is on the long (or intermediate) run rather than the short run, the long run marginal costs were chosen as the reference case. Since these marginal costs are a function of the costs of inputs, such as for example feed, other output prices (beef) and technical change, using information on actually observed changes in input and output prices over the period 2000 till 2005, updated marginal costs for the year 2005 were simulated.

Next, the simulated marginal costs were reconsidered in the context of recent quota market information (quota price in 2005 to 2007). For this, information on quota prices as well as information on the particularities with respect to implementation of the milk quota regime in various member states were assessed (e.g. possibilities and limitations with respect to tradability of quota). Based on this analysis it was concluded that for the modelling exercise the UK, Sweden, Hungary, as well as the EU7 are considered to be structurally under-fulfilling their respective quotas, meaning that there is no quota rent associated with these Member States and therefore their raw milk prices equal their marginal costs. All other member states (excluding Bulgaria) face binding milk quota during the 2005 base year. Because an inherent uncertainty remains with respect to the determination of marginal costs of milk production and because there might be a debate about the proper length of run that has to be considered, it was decided to make this parameter subject to a sensitivity analysis.

Baseline and scenarios

The baseline for the analysis provided in this report is the policy as defined in 2003 (Luxemburg agreement). The main elements of this policy include a cut in intervention prices, an increase in milk production quota and direct payments based on past allocation of quotas. The baseline is defined over the period 2005-06 to 2015-16. Although a discussion of the period 2005-06 to 2007-08 is

provided, the focus of the subsequent analysis is on the period from 2008-09 to 2015-16. To provide an insight into the very long run, the report provides additional results for the year 2020-21.

The analysis considers the four following scenarios:

- Phasing out quotas: 1% annual quota increase from 2009-10 to 2014-15; quota removal in 2015-16; this scenario is named Q1.
- Phasing out quotas: 2% annual quota increase from 2009-10 to 2014-15; quota removal in 2015-16; this scenario is named Q2.
- Quota Removal in 2009-10; this scenario is named QR-09.
- Quota Removal in 2015-16; this scenario is named QR-15.

Baseline and scenarios only differ by the level of quota or the existence of the quota system. All the other elements of the policy mix are identical.

Baseline scenario: RESULTS

At the EU level, the main element is the increase in the demand for protein which implies an increase in the SMP price. In contrast, the EU demand for butter decreases over time while the aggregate demand for fat marginally increases. At the beginning of the period the price of butter is greater than the intervention price. The decrease in butter demand generates a slight decrease in the domestic price of butter. However, as it is the case for SMP, the domestic price of butter remains larger than the intervention price. Thus both SMP and butter domestic prices remain above the intervention price levels throughout the projected period. In the baseline scenario, the EU does not use any domestic or export subsidy to sustain the domestic price of dairy products. As a consequence of an increase in SMP price and a flat butter price, the farm milk price increases (about 1% a year). This increase in farm milk price induces an increase in the production of milk in countries for which the quota on milk production was not binding (Sweden, UK, EU10 countries, Bulgaria), leading to a marginal increase of about 0.1% a year at the EU level.

As regards other dairy products, due to the positive trend in their demand, the consumption of cheese and fresh products increases over time. On the contrary, the consumption of liquid milk decreases. The combination of an increase in the demand for dairy products in the EU and a stagnation of milk production due to the quota system is a decrease in the EU's exports of dairy products: EU exports, in fat and protein equivalent, decrease by 11% and 14% respectively from 2008 to 2015. This arises while a growing demand in the world was assumed. However, it should be acknowledged that the EU does not use export subsidies to sell the dairy products on the world markets.

Summarizing the Baseline scenario, the increase in the domestic demand for dairy products induces an increase in the farm milk price. As milk production quotas are not expanded, the EU milk production remains stable. The production of dairy products for final consumption increases at the expense of the production of industrial products (i.e. SMP, WMP and butter). The EU exports gradually decrease.

The impact of removing quota. Comparison of dairy market situation in 2015-16

The different scenarios of phasing out quotas lead to a similar situation at the end of the period of analysis. In absence of quotas, the EU milk collected production increases by 5.0% which causes a

10.3% decrease in farm milk price. This price decrease is relatively small and is explained by the existence of intervention price. For butter, the domestic price is equal to the intervention price and the price adjustment is modified as export subsidies (and domestic subsidies in a lower extent) are reintroduced in order to sustain the domestic butter price, which declines by 4.5% (see Table below). On the other hand, the intervention price does not play a role for SMP, as the domestic price remains larger than the intervention price, allowing a greater fall for the price of SMP that declines by 10.3%.

Situation 2015-16. Index of production, consumption and price when quota are removed (index 100= Baseline situation) and percentage price changes as compared to 2008-09.

	Production Index	Consumption Index	Price Index	Price Percentage change from 2008-09
Raw milk	105.1		89.7	-3.8%
Butter	110.5	101.5	95.5	-8.2%
SMP	123.4	105.2	89.7	+0.5%
Liquid milk	101.2	101.2	93.4	-1.9%
Cheese	101.8	100.8	91.7	-1.5%

2008-09 results were obtained using 'normal' market conditions

The decrease in farm milk price induces a decrease in the domestic price of all dairy products. Their consumption thus increases. However the increase in consumption remains small as EU demand is rather price inelastic and the price decline for dairy products is limited, varying from 4% to 10% depending on the product. Therefore the increase in production of dairy products induces a significant increase in the EU exports and mainly the exports of industrial products. On the whole, 80% of the additional production of fat is exported on world markets and 70% of the additional production of protein is exported, leading to a decrease in world prices.

As compared to the Baseline, producers' surplus decreases by 4 billion € as the negative effect of price decline is larger than the positive effect of production growth. Consumers benefit from the decrease in price (at EU25 level this amounts to about 3.7 billion €) while taxpayer cost is increased by the cost of sustaining the butter price. The processor surplus increases, leading to a small decline in the net welfare.

It should be noted that the decrease in producers' surplus integrates the decrease in quota rents, that affects the value of quotas as an asset (since quotas correspond to a 'right to produce'), meaning that part of the loss of surplus will be borne by owners of quota who are not always identical to the producers.

SOFT LANDING scenarios: RESULTS

The two scenarios that fit in a strategy of 'soft landing' are considered to be those where quotas are increased gradually from 2009-10 to 2014-15. In scenario Q1 quota are increased by 1% per year during the phasing out period after which quota are removed in 2015-16. In Scenario Q2, the yearly increase of quota is 2%. The results of these two scenarios are very similar even if it is in scenario Q2 that the evolution of prices and production is smoother. During the soft landing period, the EU milk production gradually increases: by 0.7% per year in Q1 and by 0.8% per year in Q2.

The increase in milk production is not evenly shared among countries. In a first group of countries (Austria, Netherlands and Spain in scenarios Q1 and Q2, plus Belgium, Hungary, Ireland and Italy in scenario Q1), the increase in production is equal to the increase in quota. However, at the end of the soft landing period the quota rents are small as a consequence of the decrease in the farm milk price and the increase in marginal costs following the increase in production. In a second group of countries (UK in the case of scenario Q1; UK, Portugal and Czech Republic in the case of scenario Q2) the production decreases. This is a consequence of the negative price effect of the global increase in EU milk production. In these countries the initial quota rent was small (or equal to 0) at the beginning of the period. For these countries therefore the decrease in farm milk price thus induces a decrease in production. Finally, in a third group of countries, the increase in production is lower than the increase in quota. In these countries the quota rent at the end of the period of soft landing is no longer positive (equal to zero).

In both scenarios, removing quota in 2015-16 does not cause a sharp increase in the production. This is because quota rents at the end of the soft landing period are small on average. Thus, in 2014-15, the average quota rent amounts to 0.02 €/kg in scenario Q1 and less than 0.01 €/kg in Q2.

During the 'soft landing' period, the farm milk price remains roughly stable as the increase in demand roughly compensates the increase in production. The difference in farm milk price between these scenarios and the Baseline scenario increases over time in response to the increase in the difference of production. In 2015 the EU milk production is about 5% larger than in the baseline, whereas the EU farm gate milk price is about 10% lower than in the baseline.

During the 'soft landing' period, the SMP price remains roughly stable (Q2) as the demand for protein increases at a similar rate than the production. Since the SMP price remains significantly higher than the intervention price no export subsidies are needed to sustain the price of protein in the EU. As compared to the Baseline, the price difference increases over time.

Because more fat is produced and because fat demand increases slowly, butter price decreases. However, the decrease is relatively small as butter price reaches the intervention price in the short term (in 2009-10 for Q2 and 2011-12 for Q1). Thus from this date to the end of the simulation period, policy measures are needed to sustain the butter price. To do so, export subsidies are introduced to maintain the domestic price of butter equal to the (effective) intervention price.

As compared to the baseline, prices of dairy products are slightly lower, by 5 to 10% in 2015-16. Due to lower prices, there is some additional consumption, but the increase is limited, and so the increase in milk production is mainly exported. More than 70% of the additional production (compared to baseline) is exported on the world market. Export subsidies are used to export fat products.

The welfare impact is mainly a transfer of surplus from producers to consumers. As compared to the Baseline scenario, producers' surplus decreases by 1.9 billion € in Q1 and 2.6 billion € in Q2 on average over the period 2008-2015 while consumers' surplus increases by almost 1.8 billion € in Q1 and 2.4 billion € in Q2.

HARD LANDING scenarios: RESULTS

As a consequence of quota removal, the production increases sharply during two years: the year where quotas are removed and the following year. The increase in EU production is about 5% with the main part occurring the first year. This is because in a lot of countries, production was restricted

by quotas and the model assumes a relatively quick adjustment. In practice, it is likely that the increase in production would occur over a longer period. The increase in production causes a rather sharp decrease in the EU milk price, by about 10%.

The increase in milk production induces a decrease in SMP and butter price. While the SMP price remains higher than the intervention price it is not the case for butter which reaches the (effective) intervention price. In absence of an intervention price policy the decrease in butter price and consequently the farm milk price would be more pronounced.

Following the two years of adjustment, the increase in production becomes lower and mainly due to the increase in demand and accompanied by a price increase. The increase in EU farm milk price is rather limited as it is only due to the increase in the protein price while the fat price remains sustained (through the intervention price of butter). As it is the case in the 'soft landing' scenarios, the additional production is mainly exported on world markets.

Likewise, the welfare impact is mainly a transfer of surplus from producers to consumers. As quota removal leads to a significant transfer of surplus from producers to consumers, an early quota removal leads to a larger decrease in the average producers' surplus over the period 2008-2015 and to a larger increase in the average consumers' surplus.

It is important to note that, for scenario QR-15, the evolution of production of the different dairy products is not smooth. Before removing quota, the production of industrial products gradually decreases while after quota removal it sharply increases. This could lead to additional adjustment costs at the processing level. It is less the case for cheese production, as prior to quota removal the production of cheese gradually increases to fulfill the increasing demand in the EU.

Sensitivity analysis

Sensitivity analysis is done with respect to export subsidies (no subsidy case), low autonomous demand growth, low marginal costs of production, and a WTO agreement including gradual phasing out of export subsidies in a 6-year period starting from 2009 as well as a gradual decrease in import tariffs over the same period.

Results are relatively stable, at least given the range of sensitivity analysis performed. Among the different cases studied, the highest sensitivity is found for the marginal cost assumption. Assuming lower marginal costs (by about 25% in average), the EU milk production after quota removal would be about 9% larger than in Baseline (compared to +5% with the standard marginal cost assumption) while the EU milk price would be 17% lower than in Baseline (versus -10% in the standard case).

The impact of the 'WTO' variant is relatively small (EU milk production and price are respectively 0.4% and 1.3% lower than in the standard case in 2015-16). This is because the positive effect from the decrease in import tariffs in the RoW partly compensates for the negative effect from the removal of export subsidies. It is worth mentioning that, in 2015-16, in the standard case only fat products were exported with export subsidies, thus the removal of export subsidies leads mainly to a change in the composition of the EU exports rather than to a significant drop in EU exports: exports of butter (and SMP) decrease (as compared to the standard case) while exports of WMP and cheese increase.

The demand-related sensitivity analysis (no subsidy, low demand) show a rather modest impact on prices as well as quantities as compared to the standard scenario.

As regards the sensitivity analysis, the results of the low marginal cost (or high quota rent) sensitivity analysis show that assumptions on quota rents significantly matter to assess the final market impacts.

Concluding remarks

From the numerous results generated from the model simulations some main patterns can be observed.

- The impact assessments of scenario Q1 and Q2 demonstrate that a gradual phasing out of quotas leads to a smoother price adjustment to a without quota situation, enabling a soft landing for producers and processors, in comparison to an abrupt removal of quotas;
- All scenarios rely on the support mechanism for butter: in general butter prices quickly hit the intervention price floor. Or, alternatively, the EU is not competitive and will remain reliant on export subsidies for butter. In the absence of production limiting quotas (and unchanged market policy measures), such a situation would lead to increased market interference by market regulators through subsidies;
- As compared to the gradual phasing out quota scenarios (Q1 and Q2), the quota removal scenarios not only generate a relatively big shock, but they also imply a more uneven development over member states. From an efficiency viewpoint the one shot-removal scenarios benefit low cost (competitive) producers. The costs of adjustment, such as exit costs, might be higher, however;
- As compared to the Baseline, all scenarios considered significantly affect the production of industrial products: as compared to the baseline where their production tends to decrease, this trend is reversed into an increase. Although not unchanged, the production patterns of products for final consumption (e.g. fresh dairy, liquid milk, cheese, etc.) show a more stable behavior;
- Since demand for dairy products in the EU is inelastic and the obtained price declines are limited, the increases in EU dairy production lead to significant increases in EU exports. Where the considered scenarios generally improve the EU's market presence through the use of export refunds (at least for butter), they also affect the world market price levels: the induced price declines on world markets are of the same order of magnitude than the price declines observed within the EU market;
- The different scenarios induce a significant shift of surplus from producers to consumers. The producers (farmers) loose and the consumers gain. Producers loose as negative price effects are significantly more important than positive quantity effects. As compared to the Luxemburg agreement the taxpayer is only marginally affected. The processors benefit from the new situation as they can expand their production. On the whole there is no significant net welfare gain to the EU because part of the potential gain is 'exported' to foreign consumers who benefit from lower dairy product prices.
- The decrease in producers' surplus integrates the decrease in quota rents as well as price effects. Because quota, which corresponds to a 'right to produce', is an asset, the decrease in quota rent will affect the value of this asset. This means that part of the loss of surplus will be

borne by owners of quota who are not always the producers. The relative share of loss that is borne by dairy producers rather than owners is variable among countries. It depends, among other elements, how the market for quota is organized, if any. The disappearance of the quota rent will ease the possibility for new producers to enter dairy production.

Qualifications and discussion

The model analysis assumes a rather quick adjustment of the dairy sector to a new equilibrium situation. In reality this adjustment process might be more sluggish (in particular relevant for the one shot-quota removal scenarios). Whereas the primary milk supply part takes into account some dynamics (adjustments in herd stocks, impact of lagged prices) it remains difficult to foresee how expectations and producer behavior will exactly adjust in the light of such a structural brake in the policy regime.

Whereas the production expansion impacts found are in general rather limited, for some countries larger expansion effects were found. It is our impression that the production increases are feasible within the current system of environmental regulations, but it was beyond the scope of this analysis to do a detailed check.

Whereas the supply model accounts for the role of quota rents, it should be noted that in the longer run also rents on other fixed factors (notably land) might adjust due to the policy changes. In the context of higher prices for crop production and fully decoupled payments, it is possible that more producers than anticipated will stop producing milk (the higher price of crops has two effects a direct one on feed cost and an indirect one on the opportunity cost of land). This may lead to an increase in milk production lower than the one simulated in this report. However, because the demand for milk is rather price inelastic this would induce higher prices for milk (as compared to those simulated) which in turn might encourage producers to increase their production. The results (in particular those relative to the quantities) thus seem robust. This is also confirmed by the sensitivity analysis.

The modeling analysis focuses on 'normalized' conditions. This implies that incidental fluctuations both at the supply side and the demand side are not accounted for by definition. However, such changes (e.g. the recent drought in Australia) might influence the actually observed market situations quite significantly. Nevertheless, in terms of our model, with its inelastic behaviour of supply and demand, 'small' shocks might easily induce strong price fluctuations. However, at the same time it underscores the need to -in an analytical sense- try to separate such impacts from the impacts generated by policy changes. In general, the policy scenario's simulated, with finally the full removal of the quota, will make the EU dairy sector more subject to world price fluctuations and volatility. In absolute values the results of this study are obviously sensitive to the conditions on the world market (as shown by the actual 2007 situation of markets). However in relative values, the results are much less sensitive as the mechanisms depicted will remain.

Table of Contents.

1	Methodology	10
1.1	General characteristics of models to be used.....	10
1.2	The model of the whole dairy industry.....	11
1.3	The dynamic model of milk and beef supply	15
1.4	Elements of qualification of the models	20
1.5	Extension of results to Romania and Bulgaria	25
1.6	Specific issues.....	25
1.6.1	Quota rents and evolution of marginal costs.....	25
1.6.2	Evolution of demand	37
1.6.3	Limits and interpretation of results	38
2	Quantitative analysis of the impact of different policy scenarios on the EU dairy sector	39
2.1	Definition of scenarios.....	39
2.2	Results of each scenarios	43
2.2.1	Baseline	43
2.2.2	Scenario 1: Phasing out quota - Q1	46
2.2.3	Scenario 2: Phasing out quota – Q2	52
2.2.4	Scenario 3: Removing quota in 2009	58
2.2.5	Scenario 4: removing quota in 2015	64
2.3	Comparison of scenarios.	70
2.3.1	Situation in 2015-16 when quota are removed.....	70
2.3.2	Comparison of the four scenarios from 2009 to 2015.....	72
2.4	Sensitivity Analysis	84
2.4.1	Analysis of sensitivity: Scenario Q1	84
2.4.2	Analysis of sensitivity: Scenarios Q2, QR-09 and QR-15	92
3	Lowering the super-levy: a qualitative assessment	94
4	Concluding remarks	96

1 Methodology

1.1 *General characteristics of models to be used*

The core of the study is to perform a quantitative analysis of the impact of different quota policy scenarios on the dairy sector. In particular, the analysis of phasing out or abrupt expiry of the milk quota regime is at the core of the analysis. These scenarios will be compared to a reference scenario which consists in the roll-over into the medium/long-term of the system in accordance with the current Council regulation, for the 27 EU Member States.

To do so it is requested to use quantitative models. Given our understanding of the milk sector, such models need to have some specific features that are explained below:

- Because policy instruments apply to both the agricultural product and processed products, it is requested to use a model that considers the whole chain from milk supply to final demand for dairy products.
- Because milk is a composite product that contains fat and protein, it is needed that the processing stage of the model takes into account the feasibility of the production. In other words, the model needs to integrate a balance for fat and protein.
- Because the EU is a large exporter on the world market (as well as an importer for some products), it is needed to have a representation of the world market for the main internationally tradable dairy products.
- Because there is a broad set of policy instruments used in this sector (on the EU domestic market as well as trade instruments), the model needs to be able to incorporate the various instruments and their economic effects.
- Because the horizon of analysis is about 10 years, the model needs to incorporate the evolution of demand (that is change in the demand that are not due to price effects) as well as technical change at the supply side.
- Because milk and beef production are linked it is needed to consider the impact of beef policy (and thus beef prices) on the milk supply. At the milk production level, it is obvious that production costs and quota rents need to be well estimated as it will strongly determine the competitiveness of milk production.

In order to perform this study we use two complementary models:

- The first one is an integrated model of the whole dairy industry that takes into account the milk supply, milk processing into final dairy products and demand for dairy products. This model will be used to estimate the impact on milk and dairy markets of alternative policy scenarios.

- The second one is a model that focuses on the milk and beef supply in the different EU member states. It will be used to provide additional results concerning the supply side. It is important to mention that the two models are fully consistent. Thus, the supply module of the model of the whole dairy industry is a simplified version of the milk and beef supply model.

1.2 The model of the whole dairy industry

Using the general framework developed by Chavas et al. (1998), Bouamra et al. (2002) have developed a spatial equilibrium model of the dairy sector integrating the vertical structure of the industry. This model was recently improved in order to extend the model to deal with international trade, and to better take into account supply response of milk (Bouamra et al. (2006)). The European dairy model that is used for the study has the following characteristics:

- Partial equilibrium model of the dairy sector including milk supply, processing of milk in dairy products, demand (both domestic and foreign) for dairy products.
- Hedonic model that distinguishes the two main components of milk, that is fat and protein, allowing for a balance between supply (in the raw milk) and uses (in final dairy products) of these two components.
- Multi-periodic model taking into account year by year changes in demand conditions (change in the demand due to non price effects such as income changes, taste changes, ...) and in supply conditions (technological changes). The model includes trends in demand that were estimated using historical data on consumption (over a long period, about 30 years depending on countries and products) which are used as shifters of the demand function for each dairy product in each country or group of countries. This is needed to analyse market conditions over the simulation period (till 2015-16 plus 2020).
- The model incorporates a dynamic element in the supply side. The milk supply curve of a given year depends on past prices and cow stocks.
- The model is devoted to comparative analysis which means that results of scenarios need to be compared to a reference scenario.
- Country coverage is the following:
 - EU15: every EU15 member (14 countries as Belgium and Luxemburg are aggregated) is represented
 - EU10: Poland, Hungary, Czech Republic and an aggregate of the seven other countries that join the EU in 2004 are represented
 - EU2: Bulgaria and Romania are not included in the model at present. The impact of the reform in these two countries will be analysed in a simplified way using the results from the other acceding countries.
 - All results could be computed for EU27 as an aggregate.

- One exporting area: Oceania which is the aggregate of New-Zealand and Australia
- Four net importing regions: CIS (Commonwealth of Independent States) and the rest of Europe (including Turkey), Asia, Africa and Middle East countries, and America.
- A representation of the following policy instruments:
 - Price support : Minimum price for Skimmed Milk Powder (SMP) and butter, consumption subsidies for SMP and butter, production subsidies for casein
 - Border measures: Import duties (for the EU as well as importing areas), tariff rate quotas (TRQs), export refunds
 - Supply control: Production quotas including the fat correction element
 - Direct payments: decoupled payments
- 14 dairy products characterised by their fat and protein content thus allowing for establishing accounts in weights as well as in fat and protein. Some of these products are internationally traded while some others are only traded within the EU. The list of products is the following:
 - Butter, Skim Milk Powder, Whole Milk Powder, Casein
 - Condensed milk, Liquid milk, Cream, Fresh products
 - Six categories of cheese: Fresh cheese, Semi hard cheese, Hard cheese, Blue cheese, Soft cheese and Processed cheese
- Stocks are not considered in the model. Rather, prices and subsidies are determined by the model in order i) to clear the market ii) to be consistent with the different regulations (WTO constraints on subsidized exports, intervention prices, ...). The policy scenarios are analysed taking into account their 'sustainability' that is they should not lead to building stocks.
- The model includes a milk supply module which is a simplified version of the more elaborated econometric model of beef and milk supply (see details on this model in the following §1.3).

Figure 1 illustrates the trade flows that are taken into account in the model. Fixed imports for EU25 represent the trade flows that come from the rest of the world except from Oceania and fixed imports of the importing regions include trade flows from other countries than EU25 or Oceania. These imports are considered as exogenous. The fixed exports for EU25 deal with exports of products that are not modelled as commodities exported on the world market in the model (mainly some categories of cheese and fresh dairy products).

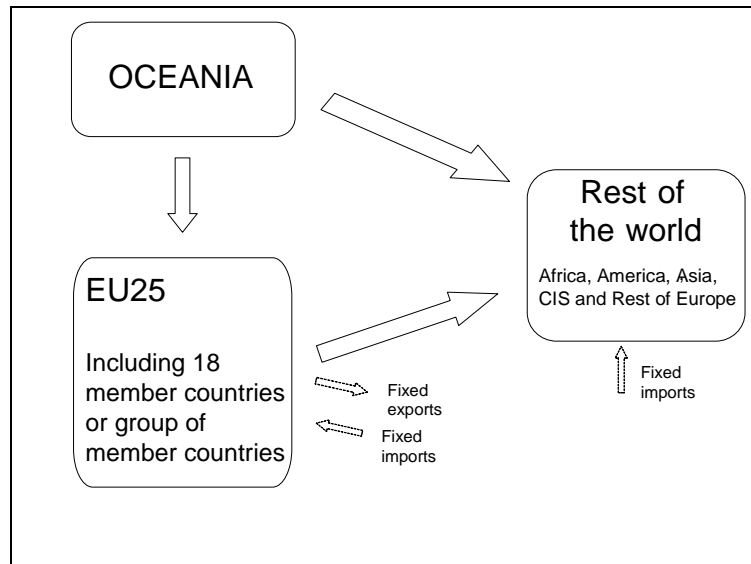

Figure 1. Regions and trade flows considered in the dairy industry model.

We present in Table 1 a list of the parameters of the model, the list of policy variables that affect the results (a full set of these policy variables composes a 'scenario') and a list of the outputs of the results of the model.

Table 1: List of the main parameters, policy variables and outputs of the dairy industry model

	Countries	Parameters	Policy Variables	Results
RAW MILK				
	EU25 regions	Elasticity of supply	Quotas	Milk production
	Oceania	Lagged adjustments	Decoupled payments	Milk price
		Quota rents		Price of components
		Technological progress		
		Fat and protein content		
FINAL PRODUCTS				
	EU25 regions	Processing costs	Production subsidies (casein)*	Production
	Oceania	Fat and Protein composition	Intervention price	Consumption
		Demand function (subsidised and non subsidised)	Consumption subsidies (butter, SMP)*	Prices
TRADE				
	EU25 regions	Transportation costs	Subsidized Export constraints	EU intra trade
	Oceania	Import demand functions (RoW)	Import access commitments	EU exports to RoW
	RoW regions		Import tariffs	EU imports
			Export subsidies (EU)*	Oceania exports
				RoW imports
				World prices

(*) In the standard utilisation of the model, subsidies are endogenously determined. They are determined in order i) to respect the different constraints that could limit their utilisation (WTO commitments on export subsidies, any restriction on the use of domestic subsidies) and ii) to have a domestic price for butter and SMP as close as possible to the intervention price.

1.3 The dynamic model of milk and beef supply

The existing tool of the European primary milk production forms the basis of the reduced form milk supply relationships, as included in the EU dairy industry model (see discussion above). The primary sector's milk supply model is designed to simulate the impact of dairy and beef policy instruments on milk and beef outputs, feed used as an input into milk and beef production, the stocks of dairy cows and (where possible) beef (suckler) cows, and the allocation of land to beef and dairy production (forage and grazing).

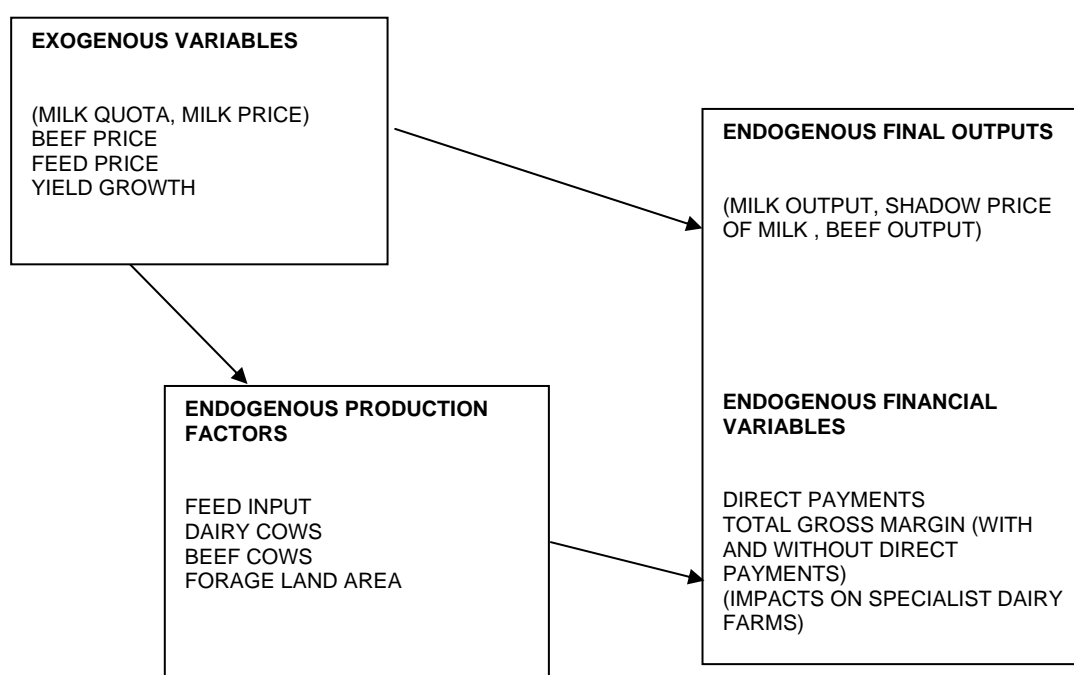

Figure 2. Schematic overview of raw milk supply model.

The raw milk supply model can simulate in two different policy settings: with milk supply constrained by quota, and without any quota restrictions on milk supply. For this study, milk price in each country is exogenous (determined by the whole industry model) and the model is used to determine the milk and beef supply, the shadow price of milk when quotas are binding, the demand for inputs, the cow stocks and to compute the farmers revenues and margins taking into account all the different payments they receive. Note that shadow price of milk obtained in this model is an endogenous variable (whereas the farm gate raw milk price is exogenous for the supply models but derived from the processing model), and that the milk shadow price and the milk supply are identical to those obtained in the whole dairy industry model as that industry model incorporates a simplified version of the supply model.

In the model, milk and beef outputs are determined in the current period, as a function of current prices (or prices and milk quota levels when quotas are in force). The adjustment of the three quasi-fixed factors, dairy cows, suckler cows and land, does not occur instantaneously. Instead, these factors begin their adjustment with a one-year lag, and take several periods to adjust fully to a price or policy change. Thus, the full impact of a price or policy change takes a number of periods to be

achieved (see Figure 2 for the direct and indirect impact of prices on supply). Given the value of the estimated parameters, most of the adjustments will take place within a two years period.

This existing EU primary milk production model has the following characteristics:

- Partial equilibrium model of raw milk production, including milk supply and beef supply. Explanatory factors are milk and beef prices, feed price, and quasi fixed factors (dairy cow stock, suckler cow stock, and land and forage area). Beef and feed prices are treated as exogenous variables.
- Dynamic model: the model takes into account short-run and medium-run adjustments in supply as a response to output and input price changes.
 - Short-run adjustment: quasi-fixed production factors (dairy cow herds, etc.) stay constant.
 - Medium-run adjustment: dairy cow stock and suckler cow stock adjust in response to price changes, which will in turn affect the milk and supply responses.
- The model includes the impact of technical change and genetic progress on milk yields.
- The model's parameters are based on empirical (econometric) estimation taking into account observed market (price and quantity) data, as well as prior information from economic theory as well as previous research.
- Country coverage:
 - every EU15 members (14 countries as Belgium and Luxemburg are aggregated)
 - New member states that joined the EU in 2004: Poland, Hungary, Czech Republic, Estonia, Latvia, Lithuania, Slovenia, Slovakia, Cyprus and Malta.
 - Bulgaria and Romania are not included in the model at present. The impact of the reform in these two countries will be analysed in a simplified way using the results from the other acceding countries (see section 1.5 for further details). Thus, all results could be calculated for EU27 as an aggregate.
- The following policy instruments are represented:
 - Milk quota
 - Milk premium (decoupled), Beef premium (might be partly coupled)
 - Estimated single farm payment (SFP) or single area payment (SAP) at the sector level
- The model provides the supply of raw milk and beef for different sets of policy instruments and as a function of exogenous beef and feed prices, and quasi-fixed factors, following a partial adjustment scheme.
- The model includes milk quota rent estimates (or marginal cost estimates) derived from empirical studies extensively exploiting data from the farm accountancy data network (2005 studies). Estimates are updated for the base year.

- The model includes a module to project purchased feed input and calculates a derived gross margin statistic.
- The model provides information about:
 - Raw milk supply, Beef supply, Milk quota, Shadow price of milk / milk quota rents
 - Dairy cow stock, Milk yield, Suckler cow stock (only for EU15); Grassland and forage area (trajectory)
 - Milk revenues, Beef revenues, Milk related premium revenues (after 2007 SFP), Beef-related premia (after 2007 mainly SFP), Decoupled payments for dairy-beef sector (SFP and SAP for old and new MS)

Two important pieces of information are the price responsiveness of the milk supply and the quota rent at the time the milk quota will be abandoned or loosened, because together they codetermine whether and by how much the milk supply is going to increase. Table 2 gives an overview of the supply responses. As can be seen current own price elasticity ranges between 0.2 and 0.3 while the lagged own price elasticity is lower. This result, which is an outcome of empirical estimation, implies that the most important response to an (expected) price change comes in the first year, with further but smaller supply response adjustments in later years. As farmers are assumed to react to (expected) prices, already the short-run response might include some cow stock management adjustments. The pattern that lagged variables show a declining impact on behaviour is a phenomenon quite regularly observed in lagged adjustment models. Note that the estimates are lower in EU15 member states as compared to new member states¹.

Table 2: Milk supply response

	BL	DK	DE	GR	ES	FR	IE	IT	NL
Milk price elasticity (t)	0.225	0.240	0.253	0.240	0.205	0.249	0.261	0.217	0.274
Milk price elasticity (t-1)	0.011	0.073	0.054	0.018	0.027	0.044	0.069	0.047	0.073
	AT	PT	FI	SE	UK	CZ	HU	PL	AC7
Milk Price elasticity (t)	0.196	0.267	0.290	0.313	0.246	0.273	0.292	0.292	0.283
Milk Price elasticity (t-1)	0.029	0.024	0.070	0.092	0.071	0.164	0.160	0.180	0.175

Source: own calculations;

The other key element of milk supply is the initial quota rent which will provide in the initial year the value of the shadow milk price. To do so we use results from Sckokai (2007) who provide recent estimates of milk quota rents in EU15 countries (additional information is provided in Box 1). From their results we will use long-run marginal costs estimates as the standard assumption (Table 3). In previous analysis we have used medium-run marginal cost estimates. However, it seems that long-run marginal costs curves could be more relevant as the aim of the study is to compare options for the long term of the dairy sector. It might be more relevant to assume that all factors can adapt. Estimates of medium-run marginal costs integrate all variable inputs plus the cost of hired labour and costs of cow stocks and machineries and buildings investments. Long run marginal costs include all these costs plus the cost of land (cf. Skokai, 2006). In EU15 member states, the medium-run marginal costs range from 50 to 70% of the farm milk price while long-run marginal costs are approximately 20 to 30% higher than medium-run marginal costs.

¹ All models for the New Member States were re-estimated for this project.

Box 1: Estimating price response and marginal costs of milk production

In order to estimate the milk price response for member states with binding quota a restricted profit function framework was estimated, where the quantity of milk was treated as a restricted output. Estimation was done using time series data on prices and quantities at member state level. The profit function framework allows for deriving the so-called 'shadow price function' for milk, which is the milk supply function providing the response of milk supply to the shadow price of milk. For member states which recently entered the EU and where previously milk production was not subject to quota constraints also a profit function framework approach was chosen. However, the milk supply equation could in this case be directly estimated.

The estimated milk supply equations describe milk supply as a function of the price of milk of the price of beef, the price of feed as well as quasi-fixed variables such as the dairy cow stock, the suckler cow stock, land, and technical change (representing the genetic progress in milk yields). Where available the price of compound dairy feed was used as a proxy for the price (or opportunity costs) of feed, otherwise a composite price index was constructed based on feed ingredients, including the price of soft wheat. The proxy for the beef price included the impact of veal prices (weighted with their share in the national total beef and veal output).

Milk and beef appeared to be complementary outputs, implying that the cross-price elasticity of milk with respect to the price of beef was positive in the medium run. Then an increase in the beef price shifts downward the milk supply curve or lowers the marginal costs of milk production. The response of milk output with respect to the price of feed was negative. Thus a feed price increase will lead to an increase of the marginal costs of milk production. The response of milk supply to beef and feed prices turned out to be inelastic, with the absolute values of the elasticities always being in the range between zero and 0.5. In general member states which heavily rely on compound feed for their dairy production showed a more pronounced response to the feed price than member states which relied on home-grown feeds.

Since the marginal costs of milk production are such a crucial variable a separate approach was followed to estimate these costs exploiting the information in the farm accountancy data set (rather than national time series data). As described in detail in Cathagne et al. (2005) marginal cost functions were estimated based on this data, taking into account several lengths of run and several functional form-specifications. Estimates for marginal costs of production for 19 regions, 3 different farm size, and when relevant 2 different altitudes (above or below 300 meters) were obtained. The obtained estimates could significantly vary with respect to region, farm type and altitude. This implies that aggregation of the farm type, region and altitude specific estimates into a national estimate will be sensitive to the method of aggregation.

As Sckokai et al. (2005) emphasize, the obtained country level estimates of the marginal cost of milk production have to be treated with care since several difficulties played a role. For example, when estimating the marginal costs of production for the long run an additional complication arises in that this estimate includes the implicit land costs and costs associated with capital assets (i.e. depreciation), which are difficult to determine, and are therefore a source of uncertainty. Finally there is the issue of aggregation where one could estimate the marginal cost of the average farm or

use alternative procedures such as estimate the marginal cost for every farm and then compute the average of these marginal costs. Because of these difficulties to determine one unique and reliable estimate of the marginal costs at member state level (which necessarily is subject to some assumptions which might be debated by others) we decided to include a sensitivity analysis on this parameter.

Table 3 provides the values that were finally chosen for this study. They are revised values of the EDIM studies cited previously. The revision concerns the method of aggregation (cf. above) as well as a better treatment of 'outliers' in the data. These results were presented in a DG Agri meeting in April 2007 (Sckokaï, 2007).

References:

Cathagne A., Guyomard H., Levert F., Moro D., Nardella M. and P. Sckokaï (2006). EDIM Research project, Annex 1 of the Report on Complementary tools. EDIM D07.04- annex 1.

Sckokai, P. (2006). EDIM Research project, report on Complementary tools. EDIM D07.04. Available at <http://edim.vitamib.com/> (section studies and reports).

Sckokaï, P. (2007). Do estimated quota rents reflect the competitiveness of the EU dairy industry?. Presentation at DG Agriculture, Brussels, April 2007.

Table 3: Actual milk price and marginal cost (€/kg at base year 2000)

	BL	DK	DE	GR	ES	FR	IE
Milk price	0.286	0.338	0.309	0.315	0.274	0.310	0.284
Medium run marginal cost	0.156	0.228	0.169	0.232	0.147	0.195	0.162
Long run marginal cost	0.197	0.301	0.252	0.313	0.193	0.257	0.213
	IT	NL	AT	PT	FI	SE	UK
Milk price	0.393	0.322	0.300	0.249	0.333	0.343	0.292
Medium run marginal cost	0.261	0.178	0.169	0.228	0.219	0.270	0.163
Long run marginal cost	0.306	0.206	0.193	0.281	0.261	0.304	0.227

Source: Marginal costs estimates and farm milk price from Sckokaï (2007) using FADN data.

Using the base year information the model is able to project the evolution of the quota rent over time. The projected quota rents will be a function of the farm gate milk price and structural variables from the supply side such as prices of beef and feed, and quasi fixed factors (cow stock and land area) and the changes therein. The quota rent information provided in Table 3 is re-examined taking into account additional information available (section 1.6.1).² The marginal costs used in the model are thus presented in Table 9 in section 1.6.1.

1.4 Elements of qualification of the models

The whole industry model was calibrated using 2000 data. We have done simulations of the 2003-2005 period and have adjusted some parameters to better take into account the evolution of dairy markets.

When comparing simulated and observed variables, two difficulties arise. The first one is to characterize the observed situation and the second one is to explain differences between observation and a more theoretical one as reflected by the model.

As shown on table 4 there are significant differences among the different statistics that are available. This explains in part some differences we observe between the results of the EDIM model and DG Agri statistics.

Note that in the model, production of butter and SMP does not include butter and SMP used for the production of processed cheese while these elements are present in published statistics. Butter and SMP used for the production of processed cheese are evaluated to be about 20% of the production of processed cheese that is about 100 kt of butter and SMP in 2000. In order to facilitate the comparison of simulated production with published data we will calculate a production of butter and SMP that includes estimated quantities used to produce processed cheese. Note also that for cheese, our estimates are relative to cheese from cow milk including processed cheese while 'ONILAIT' data excludes processed cheese.

² For a limited number of member states (those with well-functioning quota markets) some cross-checking with actual quota market information could be tried. However, in general this is not easy since markets are often not available or reflect some kind of managed trade which may hide real scarcities. Ideally one would like to check the quota rent estimate with lease prices rather than with buy/sell prices, although these are often not available. Buy and sell prices might differ, not only because of differences in productivity, but also because of differences in side conditions with quota transfers (in Portugal the amount of quota a buyer buys is reduced with a siphon of about 7 percent) and differences in fiscal treatment (in the Netherlands farmers may depreciate their quota in 8 years). Purely for reasons to illustrate the range of variation, recently quota prices were observed of 0.70, 0.50, 0.45, 0.15 and 0.05 euro per kilogram milk for the Netherlands, Denmark, Germany, France and United Kingdom respectively.

Table 4: Comparison of production data from different sources – UE 15 – 1000 t .

BUTTER	2000	2001	2002	2003	2004	2005
DG Agri	1929	1906	1945	1969	1901	1917
ONILAIT	1774	1717	1760	1763	1711	1725
EDIM Calibration	1724					
SMP	2000	2001	2002	2003	2004	2005
DG Agri	961	871	1016	976	754	760
ONILAIT	1028	945	1090	1070	845	860
EDIM Calibration	893					
CHEESE	2000	2001	2002	2003	2004	2005
DG Agri	6681	6985	6984	7085	7191	7296
ONILAIT	6231	6463	6496	6598	6740	6835
EDIM Calibration	6505					

Thus, in order to compare the results from the model and existing statistics it is required to be sure that the same definition of the product is used.

The second difficulty is to provide explanation of differences between observed situation and simulated one. One of the important elements that explains differences is the fact that in the model all adaptations are instantaneous while in reality it is not the case. In table 4 we compare the observed situation to the simulated one for years 2003 to 2005 (simulations take into account the adjustment made on the model to better fit with reality, these adjustments mainly refer to the evolution of demand and are considered to be structural changes as compared to the previous version of the model).

As a general comment, results are relatively satisfactory in the sense that differences between observation and simulation are rather small or can be easily explained. Let's now comment more precisely the results for year 2004/05 and 2005/06 (results for 2003/04 only concern EU15 as it could be misleading to aggregate very different situations for EU10 countries which had their own dairy policy before joining the EU).

In 2004/05, simulated prices for butter and SMP are lower than observed ones. This is due to the central assumption about the way markets are managed. We assume that the policy maker adjusts the level of subsidies in order to make the domestic prices of butter and SMP as close as possible to the intervention prices. Thus, export and domestic subsidies are adjusted in order to equilibrate the markets.³ In 2004/05, there are positive export subsidies (as well as domestic ones), then in our model prices of butter and SMP are very close to intervention prices (actually they are equal to effective intervention prices that is to 2747 €/t for butter and 1952 €/t for SMP). In other words, in our model based analysis, when export subsidies are positive then the domestic price of butter and SMP is equal to the intervention price. Conversely, it is only when export subsidies are equal to zero that the domestic prices of butter and SMP are larger than the intervention price. We will thus not

³ As long as subsidies are authorized, three situations can arise at the equilibrium. In the first one, the domestic price of butter (SMP) is equal to the intervention price. This means that there exist some positive subsidies which are given to fat products (protein products) in order to sustain the demand. In the second situation, even with positive subsidies it is not possible to maintain the price of butter (SMP) at the intervention price. This is because subsidies are subject to a maximum. In this case, the level of exports is not sufficient to equilibrate the market and thus the price of butter (SMP) drops under the intervention price. In the third situation, the domestic price of butter (SMP) is greater than the intervention price. This corresponds to the situation where all subsidies given to fat products (protein products) are equal to zero, as the demand is sufficient to maintain domestic prices greater than intervention prices.

reproduce a situation where export subsidies are positive and the domestic prices of butter and SMP are larger than the intervention price. This is what was observed in 2004/05.⁴

This fully explains the differences observed between actual market prices and simulated prices. Another characteristic of the model is the implicit (and strong) link between the prices of the different products. Because in the model we have i) an assumption of perfect competition and ii) an assumption of perfect homogeneity of the intermediate products that are milk fat and milk proteins, then the implicit assumption of the model is that fat and protein are valued at the same level in all dairy products. Then, there is a strong link between SMP and butter prices on one hand and the prices of the other dairy products. The observed price of cheese (SHC) is the price of Edam while in the model the price of SHC cheese represents an average of SHC price which is larger than the Edam price. Then the simulated SHC price will be larger than the observed one. Finally, note that the export subsidies we endogenously get in the model are very close to the ones that were in place.

A significant difference exists about butter and SMP exports. We get lower exports of butter and higher exports of SMP. Our estimated values are lower than actual ones. Variation of stocks partly explains the difference. Differences in the consumptions of the different products also explain differences in exports. As net exports are basically the difference between production and domestic consumption, any errors in the level of consumption has direct implications in the level of exports. Another explanation could also be linked to the composition of the products in fat and protein. Balances for fat and protein introduce constraints on the production set of final dairy products. A difference between the actual composition of the products and the ones assumed in the model may also explain some differences.

With respect to year 2005/06, we get lower prices for butter and SMP (and thus for WMP). For butter, this is because there are positive export subsidies and thus the simulated price is at the effective intervention price. For SMP, the difference is not due to this element as export subsidies are set to 0. As we got lower price for SMP in the model this means that the demand for protein in the model is under-estimated. Note that in the model the export subsidies for WMP and cheese are equal to zero while in reality they were positive which could explain (at least in part) why the demand for protein is lower than observed. It should be noted that in the model there is a strong link among the prices of the different dairy products.⁵

⁴ Obviously the mechanism we describe (adjustment of export subsidies) is a theoretical representation of the way the policy maker adjusts the level of subsidies to market conditions. In practice, it is obviously much more complex.

⁵ As they are produced from the same raw material, then the implicit price of fat and protein is identical for any production of dairy products. In reality again this link exists given long term adjustments but in the short term it is not fully the case. This means that in the model a change in the demand of one product (say WMP for example) has an instantaneous impact on the price of all other products. In practice again the link is less strong. An alternative explanation could be linked to some overestimation of the demand for WMP and cheese coupled with some underestimation of the demand for SMP.

Table 5: Comparison between observed and simulated productions, exports, consumption and prices of main dairy commodities.

EU15 - 2003/2004											
	Observed						Simulated				
	Production	Net exports	Var Stocks	Consump	Price	Exp Subsid	Production	Net exports	Consump	Price	Exp Subsid
Butter	1763	201	30	1532	3003	1740	1764	52	1712	2894	1520
SMP	1070	128	56	886	2054	650	893	87	806	2231	300
WMP	790	466		324	2501	1040	854	489	365	2540	590
Cheese	6598	334		6264	2940	740 - 1050	6714	183	6531	3347	480
EU25 - 2004/2005											
	Observed						Simulated				
	Production	Net exports	Var Stocks	Consump	Price	Exp Subsid	Production	Net exports	Consump	Price	Exp Subsid
Butter	1974	253	-51	1772	2872	950 - 1250	1996	108	1888	2747	1460
SMP	1037	226	-117	928	2052	230 - 280	1088	185	903	1952	130
WMP	855	508		347	2428	510 - 660	948	507	441	2280	457
Cheese	7586	437		7149	2957	500 - 710	7922	350	7572	3099	502
EU25 - 2005/2006											
	Observed						Simulated				
	Production	Net exports	Var Stocks	Consump	Price	Exp Subsid	Production	Net exports	Consump	Price	Exp Subsid
Butter	1988	315	-50	1723	2606	700 - 940	1982	92	1890	2540	967
SMP	1052	182	-70	940	2041	0	1116	221	895	1889	0
WMP	847	485		362	2368	80 - 100	924	474	450	2155	0
Cheese	7720	432		7288	2951	300 - 440	8130	395	7735	2984	0

Butter private stocks in 2004: -50; in 2005:+20. Not included.

Simulated production includes production used for PRC production (to facilitate comparison with observed data).

Production, stocks, exports refer to calendar year (2003 for 2003/2004)

Prices and export subsidies refer to dairy campaign. Export subsidies are value in January.

These differences in dairy products prices have implication on the farm milk price. Our simulations lead to higher decrease in farm milk price as compared to the actual change in farm milk price in the EU from 2003/04 to 2005/06. From 2003/04 to 2005/06 the actual farm milk price decreases in the EU15 by 1.16 €/100kg that is by 3.7% while in the model the decrease of farm milk price is about 4.5€/100kg.

This difference is explained by the following elements:

- The actual decrease in milk price is small as compared to the decrease in prices of butter and SMP. During this period butter prices decrease by 13.2% while SMP prices were almost constant (0.6%).⁶ Thus the observed variation of farm milk price is rather small as compared to the variation of prices of dairy products. The ‘small’ decrease in milk price may be explained by the small decrease in cheese price as farm milk price depends on butter and SMP price as well as cheese price.
- The model implicitly determines the farm milk price as a consequence of fat and protein values. As explained above, the value of fat and protein in the model are equal whatever the use of fat and protein (while it is not fully the case in reality due to adjustment mechanisms that are not instantaneous and due to some rents of differentiation on cheese and fresh products).⁷ Thus in the model the links between prices of all dairy products are stronger. Then, in the model, variations of butter and SMP prices explain well the variation of milk price. Over the period, we get decrease in butter and SMP prices as large as 12.2 and 15.3% (cf. above the explanation about dairy commodity prices). The main difference comes from SMP price. In 2003/04 the model over-estimated the SMP price while it under-estimated it in 2005/06.

Table 6: Actual and simulated changes in prices 2003/04 to 2005/06

	Actual	Simulated
Butter price (€/t)	-397	-354
SMP price (€/t)	-13	-332
Cheese price (SHC) (€/t)	+11	-363
Farm milk price (€/t)	-11.6	-45

Thus in the following analysis it is important to have in mind that dairy products prices are strongly related in the model. In reality, the adjustments take more time but they exist.⁸ The results from the model thus provide the likely trend of prices rather than short term adjustment of the different prices. Moreover, it is also important to note that the model will be used to compare the impact of alternative scenarios to a baseline scenario. The objective is then to evaluate the relative price

⁶ Using a simple model that estimate milk price as a linear function of butter and SMP prices, we found that given the observed variation in butter and SMP prices, the price of milk should have decrease by 8% rather than 4%. A limit of this calculation is linked to the small number of years used to estimate this simple model (9 years).

⁷ However, even if there are some rents of differentiation for differentiated products, the question is to know if it is farmers or firms which mostly benefit from these rents.

⁸ A good example to illustrate this is the analysis of the links between SMP, WMP and butter prices. WMP prices are strongly correlated to butter and SMP prices even if there are some short term ‘deviations’. Then in the long term changes in WMP prices are strongly linked to changes in butter or SMP prices.

changes due to policy changes rather than the absolute evolution of the prices of the dairy products. This allows abstracting from the impact of exogenous shocks that influence the observed prices.

1.5 Extension of results to Romania and Bulgaria

The current versions of the dairy industry and raw milk supply model do not include Bulgaria and Romania. As regards the raw milk supply, for both countries a raw milk supply module is designed using the available empirical data and prior information from the results obtained for other transition economies. The price elasticity of supply is assumed to be equal to 0.4 which is in line with the estimates of supply elasticity for EU10 countries (note that for Romania and Bulgaria, we assume that production of year t reacts to the price in year t and did not introduce any dynamic effect given the lack of information).

As regards the dairy industry, creating a complete model of milk processing for these countries is infeasible within the scope of this project. The main reason is that the required data needed to construct a full milk utilization balance for those countries, as well as their trade in dairy products is not available or of very poor quality. In addition, the time constraint makes impossible to integrate these two countries in the dairy industry model. The production of dairy products was therefore be modelled in a simplified way.

The basic ideas to extrapolate results to Romania and Bulgaria are the following:

- Romania and Bulgaria will not influence EU25 market equilibrium
- Rather price equilibrium in these two countries will be similar to those simulated in EU10 countries. Given that, we can deduce the change in farm milk price and thus the change in milk supply. This change in milk supply will induce a change in the production of processed dairy products that is estimated to be proportional to the change in milk supply.
- EU trade with third countries is not affected by Romania and Bulgaria change in supply (which in practice remains relatively small as compared to the adjustments in EU25).

1.6 Specific issues

1.6.1 Quota rents and evolution of marginal costs

Milk and dairy products markets are strongly influenced by the quota system. By restricting milk production, the quota system is a way to sustain prices. The key question we have to solve here is thus how the milk production in the different countries will vary if quotas are removed or expanded and what will be the price effects. To address this issue we first present the theoretical background useful to understand the different impacts of quota removal and then discuss its application to the EU case.

Theoretical background on quota modelling

The basic implications of setting a quota are illustrated on Figure 3. When (binding) quotas are set on a market, this creates a 'quota rent' that is equal to the difference between the price of the product received by farmers (P_0) and the marginal cost evaluated at the quota level (MC_0). The price equivalent to the marginal cost evaluated at quota level is also known as the shadow price of milk (P_s with $P_s=MC_0$). It is the minimum market price farmers need to get in order to supply the quota

restricted quantity. If the price on the market is lower than P_s then the production will be lower than Q_0 ; the quota will no longer be binding. If the price on the market is higher than P_s then the production will be equal to the quota Q_0 which is now binding.⁹ Thus the level of production depends on P_s the shadow price of milk.

When removing the quota constraint a new equilibrium will establish where demand equals supply (the associated equilibrium point is P_1, Q_1). As is shown on Figure 3 this will lead to an increase in milk production from Q_0 to Q_1 . Since the quota constraint is no longer there, there is no difference between the shadow price and the market price (there is no longer a quota rent that was exactly the difference between market price and shadow price). Thus farmers will respond to the price increase signal (from ' P_s ' to P_1) and thus increase their production. It is important to understand that the price signal for farmers is the evolution of the shadow price. At the aggregate level, on the market, the increase in production causes a decrease in the market price for raw milk (from P_0 to P_1). Note that the final milk price (P_1) is larger than the initial shadow price (' P_s '); then even if the milk price decreases the farmers are facing an increase in the shadow price of milk explaining the increase in their production. Finally the magnitude of the farm milk price decrease depends on the magnitude of the quota rent, the slope of the supply curve and the slope of the demand curve. Summarizing, the increase in production is larger i) the higher the quota rent ii) the more elastic the supply curve iii) the more elastic the demand curve.

When removing the quota, a second mechanism happens. The supply curve shift downwards (Figure 4). It means that at a given price a higher quantity is now produced. This is because the most efficient producers can now produce without restrictions while under the quota regime their production was restricted. Thus, on the market, taking into account this shift in supply, the new equilibrium is now $P_2 - Q_2$ with $P_2 < P_1$ and $Q_2 > Q_1$. A more detailed explanation why the aggregate supply curve shifts downward is illustrated on Figure 5, which describes a situation where milk is produced by two different producers. Producer 1 has lower costs than producer 2. Figure 5a presents the supply curve of producer 1, while Figure 5b presents the situation of producer 2. Figure 5c presents the aggregate supply curve of these two producers. When quotas are in place, the aggregate supply curve is just the horizontal sum of supply curves \bar{S}_1 and \bar{S}_2 . When quotas are removed, the aggregate supply curve shift downward as for a price larger than $P-R_1$, producer 1 now increases his production (while in the quota case he could not do so because his production was limited by the quota). Then for a given price on the market, the quantity supplied is larger.

Thus, when removing a quota system, the proper supply curve for determining the new market equilibrium is not the original one but rather the one taking into account the increased efficiency impact (or shift). This is illustrated on Figure 4. If the price on the market is P_2 , then the quantity supplied under the quota system is lower than Q_0 (that is the aggregate quota is not binding) while it is greater than Q_0 (equal to Q_2) when quota are removed. Thus for a given price (larger than $P-R_1$) the production without a quota regime would be larger than the production with the quota regime. Quotas thus introduce some cost inefficiencies (as the cost to produce a given quantity increases).¹⁰

⁹ As explained in Box 2 (p. 30), the production could exceed the quota Q_0 when the milk price is larger than the marginal cost plus the levy a producer has to pay when he produces more than the quota.

¹⁰ Quotas have other impacts that explained why they were used. In particular, it is a way to maintain production in disadvantaged areas and to limit the over-specialization of the main competitive areas of production. This argument also explains why some member states set constraints on quota trade among the different areas of their country.

Figure 3

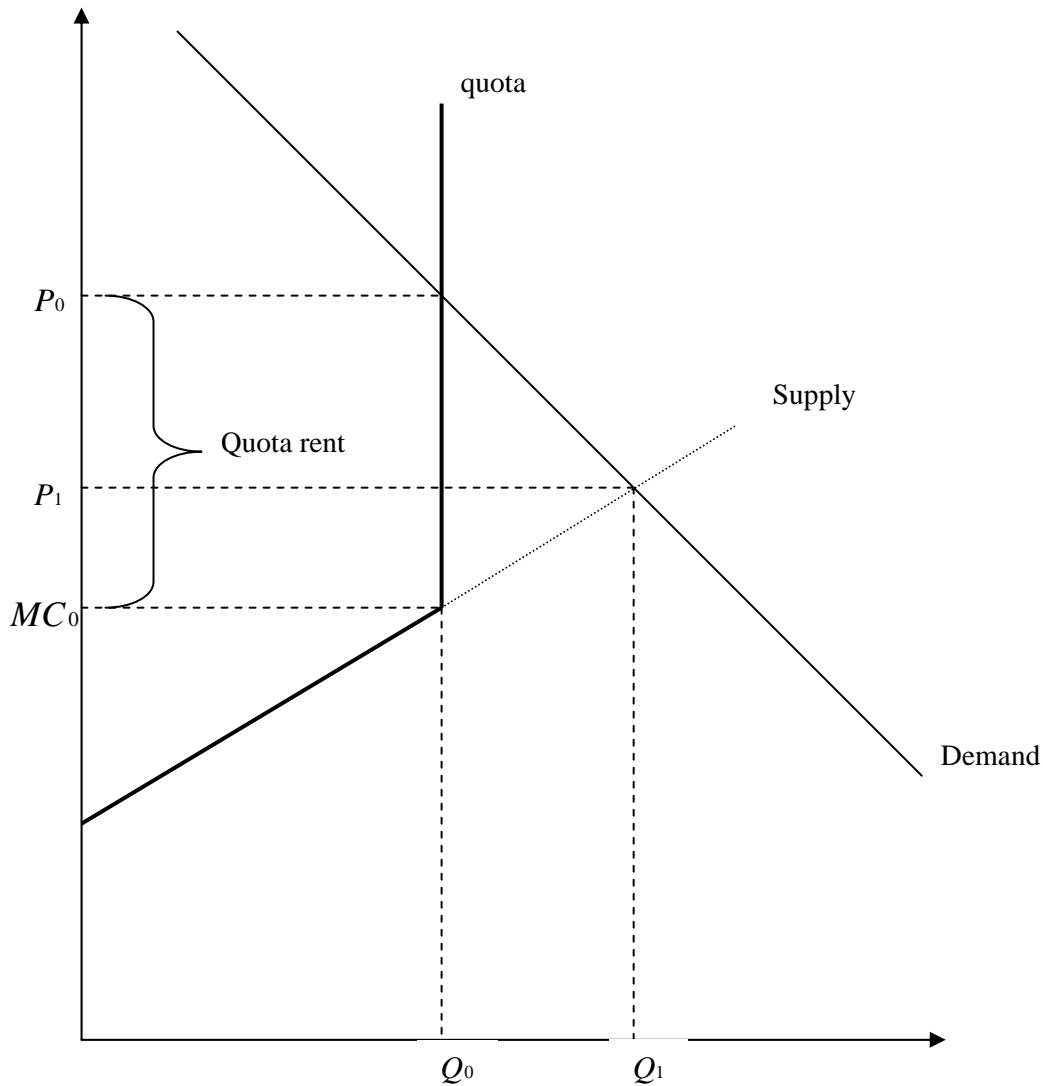
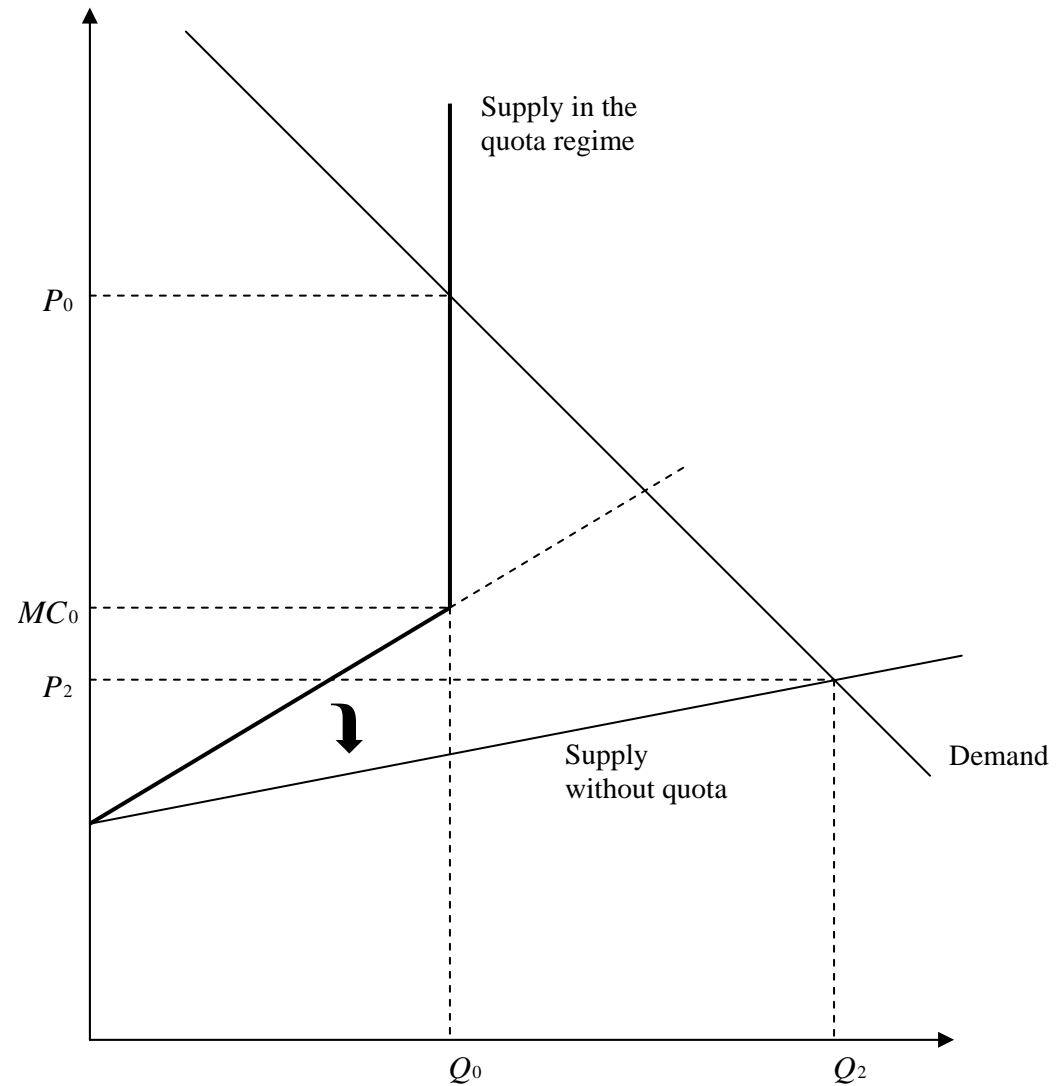

Figure 4



Legend

- Q_0 : quota level
- P_0 : price with quota
- Quota rent : $P_0 - MC_0$
- P_1, Q_1 : price and quantity without quota

- Removing quota has an impact on the supply curve
- P_2, Q_2 : price and quantity without quota
- $P_2 < P_1 ; Q_2 > Q_1$

Figure 5a

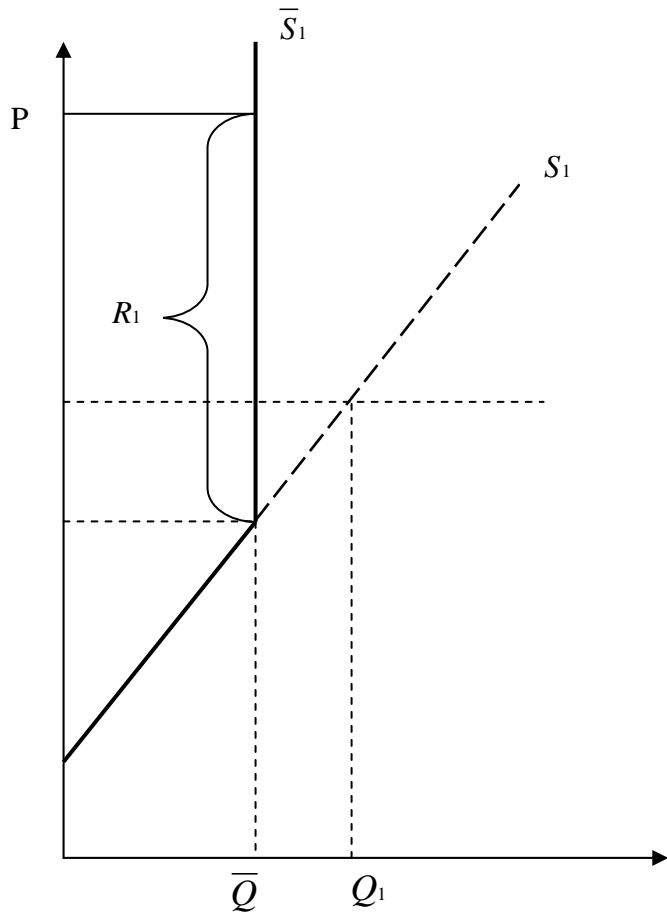

**Producer 1's
Supply curve**

Figure 5b

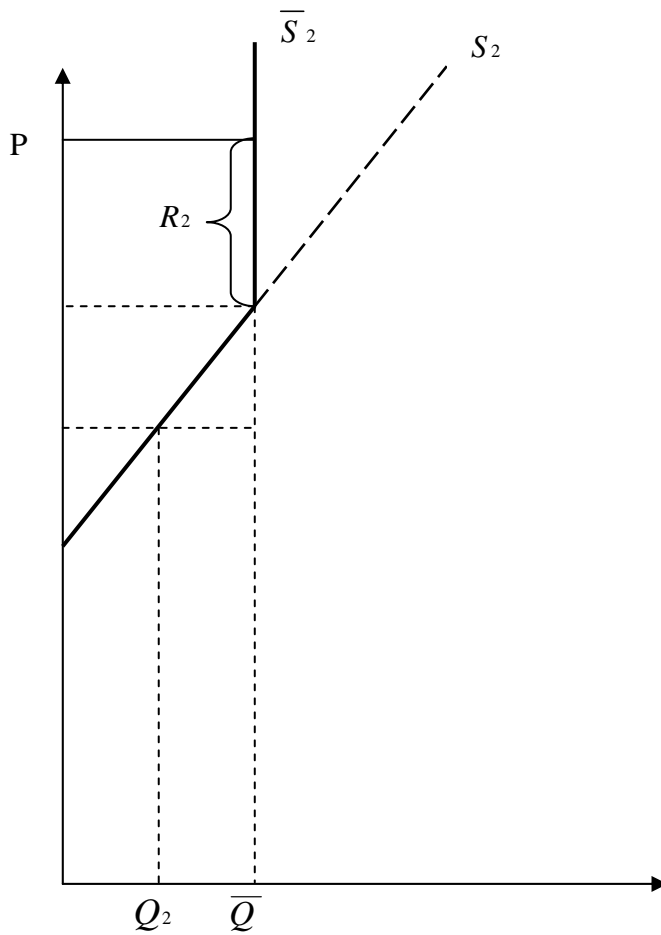

**Producer 2's
Supply curve**

Figure 5c

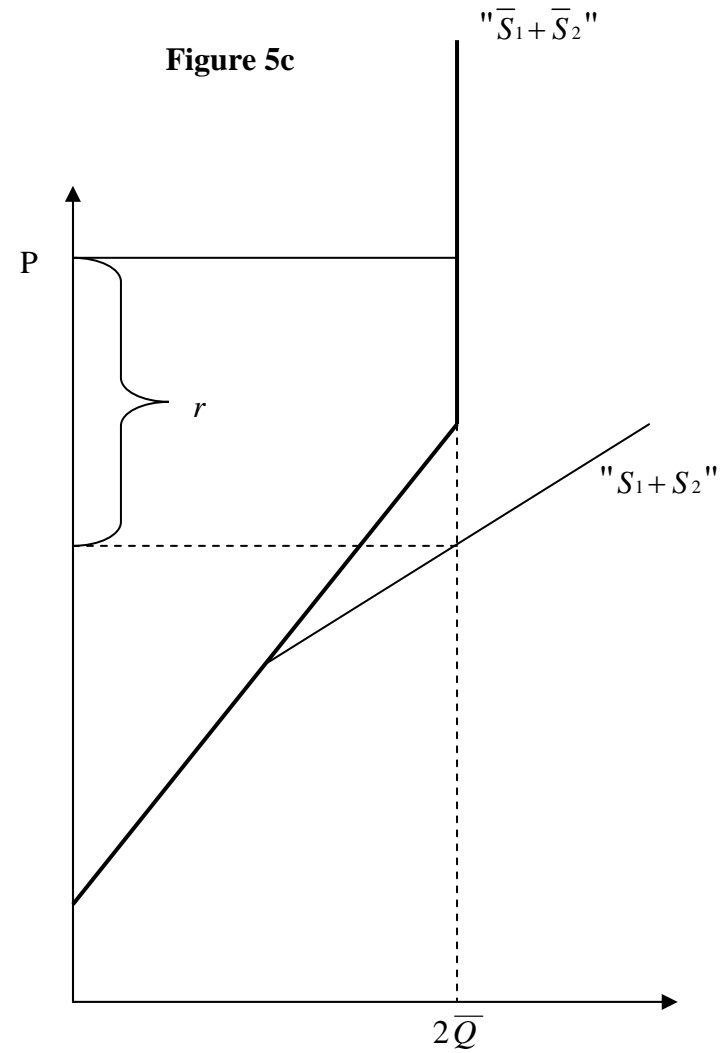

Aggregate Supply curve

The way quota are implemented and the tradability of quotas

In practice, milk production quotas are imposed through the payment of a fine as soon as the production exceeds the quota. If this rule is applied at the farm level, it means that the producer gets the market price in the limit of his quota and for the excess production he will not receive the market price, but the market price less a fine (the so-called super-levy). For a producer it is thus rational to overproduce as soon as his quota rent (e.g. R_1 for producer 1 on Figure 5a) is larger than the super-levy he has to pay.

To understand why we observe systematic over production in some EU countries it is important to exactly know how this system is applied, if producers really pay the fine or only a part of the fine because this will determine at the farm level the incentive to produce over the quota or not. In any case, a producer will rationally produce in excess of his quota as soon as the quota rent evaluated at the quota level is larger than the effective fine he has to pay for the excess production. If he overproduces, then the total quantity he will produce is such that the marginal cost of production (evaluated at this level of production) is equal to the market price minus the fine (see Box 2 for additional information on the economics of the super-levy).

A second important element of quota management is related to their tradability. While in some countries the quotas are easily tradable among farmers, in others there are a lot of restrictions to tradability (such as for example restrictions to limit quota transfer only to certain regions, or to redistribute quota according to rules that alongside economic criteria also take into account other considerations such as an active policy to favour young producers or policy to maintain producers in specific areas). In countries where quotas are not tradable or trade is strongly restricted, the quota system makes the supply less competitive by 'preventing' reallocation of production rights from relatively inefficient dairy farms to relatively efficient dairy farms.¹¹ This explains why when removing quota, the supply curve shifts downwards (see above).

On the contrary, when quotas are freely tradable, the cost inefficiencies due to the quota system disappear through quota transfers between efficient and inefficient dairy farms. In that case the supply curves with or without quota are similar (as long as the aggregate production remains lower than the quota). The mechanism is illustrated on Figure 5. Both producers have an economic interest to trade quota. Both producers face the price P and thus produce their quota. Producer 1, by increasing his production by one unit will gain R_1 . Producer 2 by reducing his production by one unit will lose R_2 . If the two producers can trade one unit of quota, they can define a price which makes each of them better off (for example by setting a price $(R_1+R_2)/2$, but any price between R_1 and R_2 is fine). Obviously, they can trade more than one unit of quota. The equilibrium reached is the following: the quota price is represented on Figure 5c and is denoted r . Producer 1 buys some quota and increases his production to Q_1 while producer 2 decreases his production to Q_2 (cf. Figure 5a and 5b).

¹¹ Quota trade might be restricted in order to maintain producers in less competitive areas in activity. Quota is thus used as a tool of 'rural development' in the sense that it is a way to maintain activities in difficult areas. This may even lead to a situation where within one country you have regions where farmers face binding quota and other regions where quota are non binding or, which is equivalent, farmers under produce as compared to the available regional quota reference quantity.

BOX 2: Lowering the super levy

As it was implicitly assumed in the graphs discussed above the super levy is large enough to preclude any milk production in excess of the milk quota. If however the policy maker would choose to lower the super levy, for example from SL_0 to SL_1 (see Figure below), the milk price less this lowered levy could become sufficiently high as to create an incentive for some producers to produce over their quota. For efficient producers (also named as infra-marginal firms) producing in excess of the quota is profitable (as shown on the Figure below) as the net milk price is higher than their marginal costs. As the graph shows, these firms have a tendency to expand their milk production beyond their individual quota level up to the point where their marginal costs exactly match with this price (i.e. $P - SL_1$). At the market level this implies that with such a lowered super levy one would observe a certain amount of structural surplus production ($Q_1 - \text{Quota}$ on Figure). The degree to which this is likely to happen will depend on the super levy reduction as well as on the distribution of the marginal costs of production (i.e. the share of very efficient farms). Note that what really accounts is the levy the producers have to pay which also depends of the way the levy is implemented at the national level.

Figure 6: Reduction of super levy and structural over-quota production

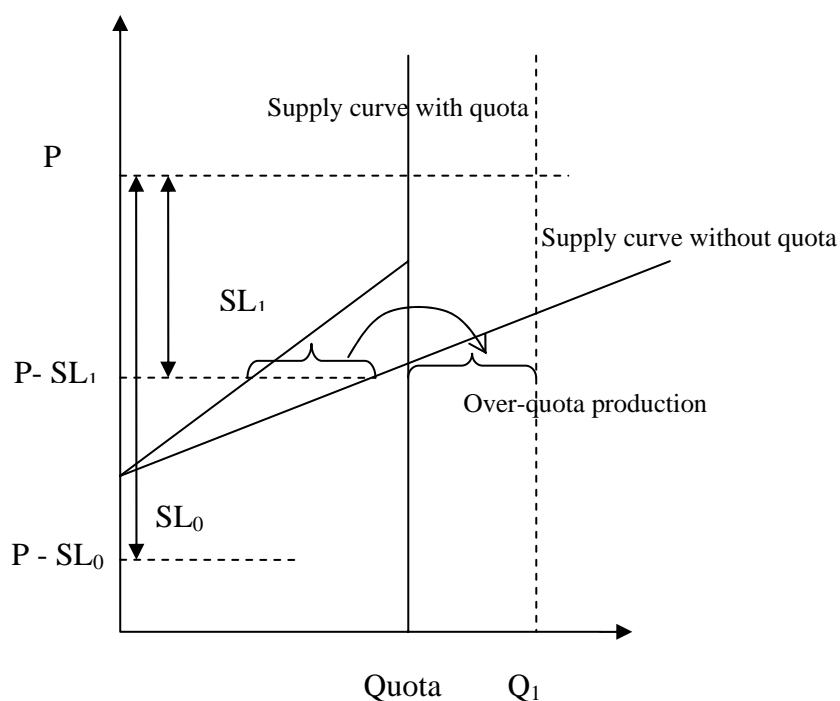

The main result is the following: **the cost inefficiencies due to the quota system disappear through quota transfers**. It means that, under tradability of quotas, the supply curve within the regime of quota is identical to the supply curve without the quota regime. In such a situation, removing the quota does not shift the supply curve.

A further consequence of the above analysis in presence of a super levy to enforce the quota is the following: in a country where quota are freely tradable, producers have an incentive purchase additional quota (and thus to produce in excess of their original quota without being subject to a super-levy) as soon as the levy they have to pay when they overproduce is lower than the price (leasing price) of the quota on the market. Conversely, if quota cannot be traded, producers have an interest to overproduce as soon as their own quota rent is larger than the levy. In reference to Figures 5, when quotas are tradable, there is production in excess of the quota as soon as the levy is lower than r . While when quota cannot be traded producer 1 has an interest to overproduce as soon as the levy is lower than R_1 . Thus, some overproduction is more likely when quotas are not tradable. We now discussed how the quota regime is enforced in the different countries and provide elements for the main milk producers in the EU.

Quota rent and quota price

By definition, the quota rent is the difference between the farm milk price and the marginal cost of production. It can be defined for each producer (cf. Figures 5a and 5b). When analysing the aggregate supply curve (at a country level for example), the quota rent is also defined as the difference between milk price and marginal cost (which is now the marginal cost of the marginal producer, that is $P_0 - MC_0$ on Figures 3 and 4).

When quotas are tradable (Figure 5c) and if the market for quota is perfectly competitive, then the quota rent and the leasing price of quota are equal. In practice, it is not the case for different reasons: restriction in quota trade, incentive to lease out for producers who anticipate to overproduce. However, there is a strong link between the leasing price and the quota rent.

Again, if markets perfectly work, the purchasing price of a quota and leasing price are linked by the following: the purchasing price is the net present value of the leasing prices over time (that is as long as the quota system is in place). For example the fact that in Netherlands the purchasing price of the quota has decreased after the announcement that the quota regime could be abandoned in 2014-15 illustrates this relationship.

Enforcement

In general the milk quota and the combined superlevy/penalty for exceeding this reference quota cause a binding constraint on EU milk production. In 2004/05 and 2005/06 the EU25's production deviated from the total quota by 0.5 and 0.3 percent respectively (slightly lower production). The superlevy penalty is currently 0.28€/kg of milk, where previously even a higher penalty rate was imposed (115% of milk price).

The way countries have implemented the quota system shows variation over countries. Although the basics are similar, variation exists in the degree of tradability that is allowed (varying from not at all, trade in limited zones, or countrywide trade), the side conditions attached to quota transfers (siphon) and the extent to which leveling off of individual farmer surplus and deficit production is organized.

Differences and variation in the way the milk quota regime is implemented in member states might explain why some countries with effectively binding quota have a tendency to slightly overproduce whereas others slightly under-produce¹². As summarized in Table 7, among EU15 countries, France, Sweden and UK produced less than they are allowed by their national quota in the observed period (2003-04 to 2005-06). This represents a deficit of production of 550 kt. Other countries (Finland, Greece, Portugal) experienced under-production but the absolute amount is smaller (about 100 kt for the three countries). Conversely, other EU15 member states, such as Germany, Italy, and Austria, produced in excess of their reference quota (about 900kt). Except for Czech Republic, Poland and Cyprus, all new member states produced significantly less than their national quota (based on marketing years 2004/05 and 2005/06).

Table 7: Excess production in the different EU countries.

	BE	DK	DE	GR	ES	FR	IE	IT
Delivery quota 2005/06	3242	4455	27768	820	6050	23880	5392	10284
Excess production	8	11	328	-50	11	-319	-8	496
% excess production	0,25%	0,25%	1,18%	-6,14%	0,19%	-1,33%	-0,15%	4,82%
	LU	NL	AT	PT	FI	SE	UK	
Delivery quota 2005/06	269	11000	2636	1912	2400	3300	14486	
Excess production	2	38	66	-27	-29	-109	-135	
% excess production	0,87%	0,35%	2,50%	-1,39%	-1,21%	-3,31%	-0,93%	
	CZ		HU		PL		AC7	
Delivery quota 2005/06	2679		1835		8726		4532	
Excess production	17		-221		296		-457	
% excess production	0,63%		-12,04%		3,39%		-10,08%	

Excess production is the average over three years for EU15 countries while it is over-production in 2005/06 for EU10 countries.

Country specific milk quota regime characteristics

To highlight the main characteristics of the milk quota policy as implemented and functioning at member state level in a systematic way we provide in Table 8 a number of characteristics of dairy sector, such as an indicator for farm structure (number of dairy cow per holding with dairy cows in 2003), information about the character of quota transfers (free trade, regulated trade, etc.), an indicative estimate of observed quota values (buying prices based on available information for years 2004-2006); and information about the existence of regional restrictions to quota trade. The lowest row indicates our choice for the prevailing quota regime as it is modeled in the dairy model. This choice is clearly based on the information provided in the upper lines of the Table.

Based on Table 8 the following observations can be made:

¹² For example the way unused quota from under-shooters to over-shooters either dilutes the levy on all excess production by every producer, or removes levy liability on some excess with balance of excess subject to a levy at the full rate. Producers normally don't know the dilution rate or extent of excess released from levy during the prevailing quota year, since this depends on the balance of undershoot and overshoot across member states. However the exact way the levy is implemented in the different countries is important as it can explain why in some countries we observe over-quota production even if the full rate of the levy is very high.

- As the row indicating the average number of dairy cows per holding with dairy cows in 2003 indicates, member states are differing with respect to farm structure and possibilities to benefit from economies of scale. It should be noted that averages can mask regional variation (e.g. difference between East and West Germany), or variation over farm types (large scale farms versus smallholder farms).
- Most EU15 Member States have a regime of free quota trade. Sometimes hybrids of free and regulated trade or exchanges are in place (regulated trade often used to favor certain groups, like starters, farm succession within family). Trade limitations could provide an explanation for structural under production (based on the outcome in a certain region), whereas it seems reasonable to assume still binding quota at the country as a whole.
- Countries facing binding quota are expected to show a valuation of quota rights which is significantly different from zero. The quota price line in Table 8 shows observed values based on information that was available for years 2004-2006. This information should be interpreted in an indicative way. Where prices are significantly above zero this signals binding quota. When quota prices are close to zero (like for example for Sweden and United Kingdom) this indicates that those countries might be on the edge or even under producing as compared to the available reference quota amount.
- As regards the new Member States, non-zero quota values were observed for Czech Republic, Poland and Latvia. They signal binding quota for these countries, whereas most other new Member States are likely to under produce.
- An observation made, but not documented in Table 8 is that quota prices show a tendency to decline, at least in the EU15 Member States, which might be due to anticipated quota abolition over time. Because quota behave partly like an asset, expiry of the quota value after some date is likely to affect its price well in advance of this date (without necessarily reflecting underlying changes in the dairy sector's marginal costs).
- Several countries apply regional restrictions to quota tradability, which might be a source of inefficient allocation. It can even explain why some countries might under produce (for example due to below-quota production in inefficient and disadvantaged regions), whereas at the same time the more productive regions in such a country face binding quota and non-zero quota prices. When looking further back in time, it can be observed that regional restrictions tend to be relaxed over time (e.g. Germany).

Combining all the pieces of information a choice is made with respect to the prevailing milk quota regime for each member state, which is used as a basis for the modeling exercise. It is summarized in the following:

- EU15 member states Belgium, Denmark, Germany, Greece, Spain, France, Ireland, Italy, Netherlands, Austria, Portugal and Finland as well as Poland face a binding milk quota constraint.¹³ This implies that their marginal costs will be equal or lower than the raw milk price received at farm gate level.
- Germany, Italy and Austria are producing in excess of their national milk quota. There is no clear way to make endogenous this surplus production in the model. We thus assume a certain level of overproduction.

¹³ Poland is facing a binding quota in 2005. However, due to a significant increase in its quota in 2006, it turns out that the production of Poland in the first years of analysis is not constrained by the quota.

Table 8: Member State specific information about milk production, quota (without land) re-allocation mechanism, and quota valuation

Country	Belgium	Denmark	Germany	Greece	Spain	France
Production / quota	At quota level	At quota level	Over production	Under production	At quota level	Under production
# dairy cows/holding	35	75	36	14	18	36
Quota trade	Regulated and free trade (within family and potential siphon of 40%)	Regulated Trade (Exchange System) ; since 2001 a 1% siphon	Regulated trade (Exchange System) system	Free Trade (5% siphon)	Regulated trade	Regulated trade;
Quota price	€0.37/kg (regulated);	€0.42/kg- €0.62/kg	€0.30/kg – €0.70/kg	Unknown	€0.27/kg	€0.15/kg
Regional restrictions to quota re-allocation	Yes	-	2 regions from 2007	No	Yes	Yes
Modeling choice	Binding quota	Binding quota	Binding quota and structural overproduction	Binding quota and structural underproduction	Binding quota	Binding quota and structural underproduction
Country	Ireland	Italy	Netherlands	Austria	Portugal	Finland
Production /quota	At quota level	Over production	At quota level	Over production	At quota level	At quota level
# dairy cows/holding	42	25	54	9	15	18
Quota trade	Regulated trade (Exchange system) (30% siphon for priority pool)	Free trade	Free trade; tax deduction for buyer	Free trade	Free trade, but 7.5% siphon reduction	Free trade and regulated trade; tax deduction for buyer
Quota price	Range from €0.10 to 0.28€kg (priority pool price 12 cent);	€0.35/kg (high productive region)	€0.70/kg	€0.50-0.70/kg	€0.24/kg – €0.35/kg	€0.28/kg (free trade); €0.04/kg (regulated)
Regional restrictions to quota re-allocation	Yes, transfers restricted to purchaser areas	Yes, no transfer from mountains, or LFA to plains	No	No	Yes, no transfer from vulnerable to non-vulnerable regions	Yes, 7 regions
Modeling choice	Binding quota	Binding quota and structural over production	Binding quota	Binding quota and structural over production	Binding quota	Binding quota

Table 8: continued

Country	Sweden	United Kingdom	Czech Republic	Hungary	Poland	Other 7 NMS
Production / quota	Under production	Under production	Under production	Under production	Over production	Under production
# dairy cows/holding	41	80	42	14	4	-
Quota trade	Free trade; tax deduction for buyer	Free trade	Free trade	Free Trade	Free trade;	Lithuania: auction; Estonia: quota traded with cows; Latvia: free trade.
Quota price	€0.07/kg -€0.20/kg	€0.02/kg -€0.05/kg	€0.07/kg	€0.07/kg -	€0.15/kg	Latvia €0.10/kg
Regional restrictions to quota re-allocation	Yes, 2 regions	Yes, for for some Scottish islands	No	No-	Yes, 16 regions	No for Lithuania, Estonia and Latvia
Modeling choice	Non-binding quota	Non-binding quota	Non binding quota	Non-binding quota	Binding quota and structural over production	Non-binding quota

The UK and Sweden, as well as Hungary, Czech Republic and EU7 are producing less than their reference quota, implying that the quota constraint is currently not effectively binding. These countries are producing along their supply curve.

For Romania and Bulgaria, they do not face quota in 2005. Thus the assumption is that the marginal cost of production is equal to the observed milk price. Then, depending of the price changes (due to the integration to the EU) and given the quota level as compared to the existing production, the model will determine endogenously if their production is restricted by the quota or not.

Change in marginal costs over time

As explained before, from Sckokai (2007) we have information on marginal costs in EU15 countries. However these estimates correspond to the 2000 situation. From 2000 to 2005 some changes occur that are linked to changes in feed prices, changes in beef prices as well as technical change. The impact of these different elements differs from country to country and results from the estimates of the econometric model of supply and observed country specific beef and feed price (indicator) patterns¹⁴.

Table 9: Marginal costs of milk production used in the model. (€/kg)

	BL	DK	DE	GR	ES	FR	IE
Marginal cost 2000	0,197	0,301	0,252	0,313	0,193	0,257	0,213
variation feed price	-0,009	-0,067	0,004	0,008	-0,008	-0,019	-0,008
Variation beef price	0,003	-0,008	-0,002	0,000	-0,002	-0,009	-0,001
Technical change	-0,011	-0,014	-0,006	0,001	-0,009	-0,011	-0,007
Marginal cost 2005	0,180	0,212	0,248	0,322	0,174	0,218	0,197
Adjustment	-	-	-	-	-	-	-
	IT	NL	AT	PT	FI	SE	UK
Marginal cost 2000	0,306	0,206	0,193	0,281	0,261	0,304	0,227
variation feed price	-0,035	-0,010	0,007	-0,084	-0,014	-0,019	-0,001
Variation beef price	-0,010	0,017	-0,006	-0,004	0,000	-0,008	-0,003
Technical change	-0,012	-0,057	-0,002	-0,004	-0,015	-0,020	-0,014
Marginal cost 2005	0,248	0,157	0,191	0,189	0,231	0,257	0,209
Adjustment	-	-	-	-	0,072	0,03	0,058
	CZ	HU	PL	AC-7			
Marginal cost 2005	0,252	0,222	0,236	0,220			

Changes in marginal costs due to variations of feed and beef prices are country-specific. They depend on the parameters of the supply function that was estimated for each member state as well as on the observed variation of beef and feed prices. The observed changes in feed prices were approximated by assuming that the feed price change correlate with the observed price changes in coarse grains (e.g. soft wheat and barley) at member state level. The beef price changes were approximated by the prices for cattle and calves per 100kg live weight (as available from Eurostat, see <http://epp.eurostat.ec.europa.eu/...>).

¹⁴ These observed price patterns could substantially differ between member states, explaining the differences in impacts on the marginal cost change. As an illustration in the period 2000-2005 in Austria the beef price increased with about 20%, whereas in Belgium it declined with about 10%. For feed prices less pronounced differences were found, but they could increase for one member state whereas they declined for another one.

In addition, in three cases (Finland, Sweden and UK) we adjust the marginal cost for the following reasons. For Sweden and UK, from the above discussion we conclude that in these countries the quota constraint was not binding. We thus assume that marginal cost equal the milk price in these countries and thus adjust the marginal cost. For Finland, producers benefit from subsidies (which vary depending on the region of production). In order to take into account these subsidies we adjusted the marginal cost. The final values that are used in the model are summarized in the following table. With respect to EU10 countries, the issue is different as their production was not restricted by quota till 2004. We report in the table the value of the marginal costs which are used in the model.

These estimates can be challenged for some countries. However, it was far from what was possible during this study to re-estimate the different marginal costs for the different countries. Rather than to use ‘experts estimates’ (which could be biased and non homogenous) we preferred to use the results of a systematic and homogenous (in the method) study. Then, we perform a sensitivity analysis to test what happens with an alternative assumption on marginal costs.

1.6.2 Evolution of demand

The change in the demand is a key issue. Previous research has demonstrated that results of the model are very sensitive to demand characteristics. For instance, previous results (INRA-Wageningen Consortium, 2002) show that, everything else being equal, a 1% increase in the derived demand for milk generates an increase in milk price by 3%. Because of the importance of these parameters, a particular attention was devoted to the demand side of the model. In particular, estimates of autonomous demand trends (defined as changes that are not explained by price changes) as well as estimates of demand elasticities come from Bouamra et al. 2006 and Trévisiol, 2005. It is shown that the demand for fat will increase at a significant lower rate than the demand for protein in the EU25.

Table 9: Annual rate of increase of fat and protein demand in the EU.

	Fat consumption		Protein Consumption	
	2010-2005	2015-2005	2010-2005	2015-2005
UE 15	0.08%	0.07%	0,45%	0,42%
UE 10	0.26%	0.24%	1,32%	1,16%
UE25	0.10%	0.09%	0,55%	0,50%

There is a lot uncertainty about the evolution of demand in the Rest of the world. In the standard version of the model, we assume a 2% annual rate of increase in the demand for net imports in the rest of the world (this rate is identical whatever the product and the regions) from 2003 to 2014. This is debatable. The difficulty lies in two facts: first we do not have time series on the net imports of the 4 areas defined in the model; second the model considers net import that is the difference between demand and supply. It is well known that the demand in dairy products increases significantly with incomes. But, it is very difficult to anticipate how supply will react in the importing countries (this will

depend on the policy developed in these countries in order to favour or not the development of their own production).

1.6.3 Limits and interpretation of results

The spatial equilibrium model of the dairy industry is mainly devoted to compare the impact of alternative scenarios on dairy markets. It has some features that need to be reminded when analyzing the results.

First it should be acknowledged that except for the primary milk supply part, in this model all adjustments with respect to the demand and the processing side are instantaneous. This is true for price and quantity adjustments and implicitly also for potential adjustments in processing capacity. In practice, reaching a new equilibrium takes more time. Due to the instantaneous adjustments the model when testing the impact of a reform provides a picture that 'exaggerates' the short term impacts of the reform. **Thus the model is not a model to predict year by year the evolution of dairy markets but rather it is a model useful to compare alternative scenarios and to test their likely impacts on markets.**

Second, the model should be used to test structural changes rather than accidental changes. This is a difficult task to distinguish between structural changes and accidental changes in supply and demand characteristics. To take an example, does the decrease in milk supply in Australia is structural or accidental? If it is structural, our analysis of the EU reform should take into account this decrease in supply capacities of our main competitor on world markets. If it is accidental there is no need to take this into account as it is a temporary event and as explained above the model is suitable to analyse structural impact of a policy rather than to deal with short term adjustments of markets. The same question arises for the EU production. In 2005 and 2006 the EU production was slightly lower than the quota. Is this due to a 'bad allocation of quotas' in some countries or a lack of visibility in the dairy policy (and thus it is in some sense 'accidental') or is it due to a structural element (consequence of decoupling introduced in 2005, competition with other productions).¹⁵

Third, the model includes a lot of implicit and explicit assumptions that needs to be reminded when discussing the results. This is particularly true about the evolution of demand, the change in milk production costs.

Fourth, if marginal costs assumptions for some countries are debatable it seems that our results at the EU level are rather robust. In other words, results for some specific countries (and especially for countries which are not the larger producers) should be considered more cautiously.

Finally, in the EU the impact of decoupling on the milk supply is still a subject of research. Because this reform is very recent we cannot observed its impacts in practice. There are obviously some theoretical works but it remains an important uncertainty. Decoupling implies more 'competition' among the different agricultural activities. The increase in cereals prices has in this context two effects on the milk supply: the first one is an increase in feed costs and thus an increase in the cost of production of milk. The second one is indirect. It increases the opportunity cost of land and thus it decreases the profitability of milk production. Some producers could therefore stop producing milk in favour of cereal production. This indirect effect is difficult to quantify.

¹⁵ By 'bad allocation of quotas' we mean that by a different allocation of the quota among farmers within the country, the aggregated production of the country would have been equal to the national quota. The 'bad allocation' could be interpreted as a lack of flexibility in the management of under and over production among farmers.

2 Quantitative analysis of the impact of different policy scenarios on the EU dairy sector

2.1 Definition of scenarios

We analyze a baseline and 4 scenarios.

The baseline is the policy defined in 2003 (Luxemburg agreement). The main elements of this policy include a cut in intervention prices, an increase in milk production quota and direct payments based on past allocation of quotas. The quantitative information about the intervention price, the quota and the direct payments are given in annex 1. The baseline is defined over the period 2005-06 to 2015-16. Results from 2005-06 to 2007-08 were discussed in section 1.4 'element of qualification of the models'. We concentrate our analysis on the period 2008-09 to 2015-16 and provide some results for the year 2020-21.

We then test the 4 following scenarios:

- Phasing out quotas: 1% annual quota increase from 2009-10 to 2014-15; quota removal in 2015-16; this scenario is named Q1.
- Phasing out quotas: 2% annual quota increase from 2009-10 to 2014-15; quota removal in 2015-16; this scenario is named Q2.
- Quota Removal in 2009-10; this scenario is named QR-09.
- Quota Removal in 2015-16; this scenario is named QR-15.

Baseline and the 4 scenarios only differ by the level of quota or the existence of the quota system. All the other elements of the policy mix are identical. In particular:

- The intervention prices are identical.
- When needed, domestic subsidies and export subsidies are used to maintain the domestic price of butter and SMP higher (or equal) to their respective intervention price.
- The trade policy is identical, that is the general rules are not modified.

Before analyzing the results, we provide in Box 3 and Box 4 some mechanisms that are important for a good understanding of the results.

BOX 3: Domestic prices of butter and SMP and the level of subsidies

In the EU, intervention prices are defined for butter and SMP. Intervention prices play two roles: a direct one and an indirect one. The intervention price is the price at which the public authority buys products put at the intervention.¹ It is thus a floor price. However, intervention purchases by the public authority are restricted both in quantities and in time. Thus, the intervention price acts as a floor price only when intervention is open and as long as ceiling quantities are not reached. This direct role is mainly devoted to a regulation of prices within the year. In the model, this role is not taken into account as the model does not deal with intra-year variations.

By setting an intervention price the public authority implicitly defines a reference market price for butter and SMP. This is the indirect role. In practice, the regulator can adjust the level of subsidies. While intervention prices and quotas are defined for a long period (several years), it is not the case for export and domestic subsidies whose levels are adjusted very frequently. In practice, these instruments are set every week by the policy makers to manage the markets. In this context, we assume that the regulator adjusts the level of subsidies in order to make the domestic prices of butter and SMP as close as possible to the intervention prices. Thus, export and domestic subsidies are adjusted in order to equilibrate the markets.

As long as subsidies are authorized, three situations can arise at the equilibrium.

In the first one, the domestic price of butter (SMP) is equal to the intervention price. This means that there exist some positive subsidies which are given to fat products (protein products) in order to sustain the demand. In absence of positive subsidies, the domestic price of butter (SMP) would fall under the intervention price.

In the second situation, even with positive subsidies, it is not possible to maintain the price of butter (SMP) at the intervention price. This is because subsidies are subject to a maximum amount or volume, which is then binding. In this case, the level of subsidized exports or consumption is not sufficient to equilibrate the market at the 'desired' price level and thus the price of butter (SMP) drops under the intervention price.

In the third situation, the domestic price of butter (SMP) is greater than the intervention price. This corresponds to the situation where demand is sufficient to maintain domestic prices at a level greater than intervention prices without the need for subsidies.

In the first situation, a change in the level of production or in the level of consumption of butter (SMP) induces a change in the level of subsidies but no change in the domestic price. On the contrary, in the third situation, changes in production or consumption induce changes in price.

1. Note that in case of butter, the public authority buys at 90% of the intervention price. In this text, we consider the effective intervention price rather than the official one.

BOX 4: The evolution of production and price of milk depending on the existence of production quotas

In a market where supply is restricted by a quota, a marginal change in the supply or demand curves has no impact on the quantity produced and consumed (Figure 7). The adjustment of the market, if any, is through price. Thus, when the demand curve shifts (that is when the demand increases or decreases), the price adjusts to the new conditions (Figure 7a). The quota rent is also modified by the same amount. Obviously, this is true as long as the quota rent is positive. When the supply curve shifts, for example due to changes in the conditions of production (e.g. technical progress that shifts the supply curve downward, increase in the profitability of alternative productions that shift the supply curve upward), the price equilibrium is not changed (Figure 7b). Only the rent is modified.

On the contrary, when supply is not restricted by a quota, any change in the supply or demand curve has both a price and a quantity impact. When the demand increases, then both the price and the quantity produced increase (Figure 8a). When the supply increases (that is when the cost of production decreases), the price decreases while the quantity produced increases. Finally, as shown on Figure 8b, if both the demand and the supply increase, the only prediction is that production will increase. But we cannot know what will be the price effect. This will depend on the magnitude of the impact of supply and demand on the price.

Summarizing, when binding quotas are in place, changes in demand or supply conditions only affect prices or rents. On the contrary, on a market without restriction, a change in the demand or supply conditions has a price and a quantity effect.

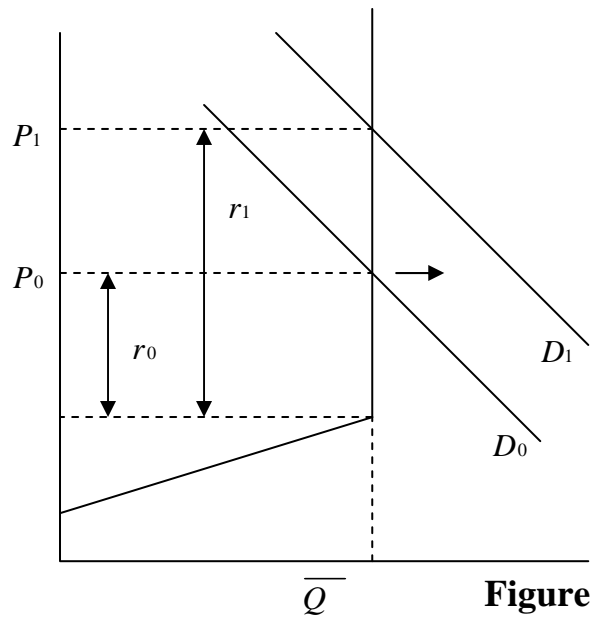
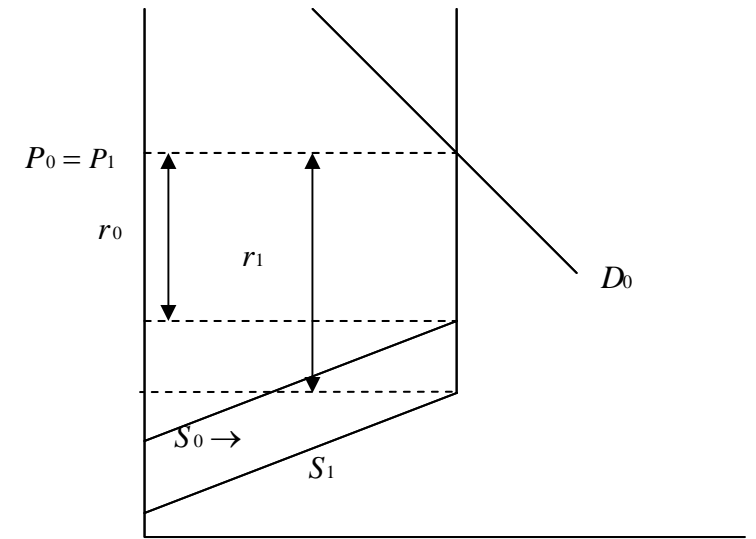
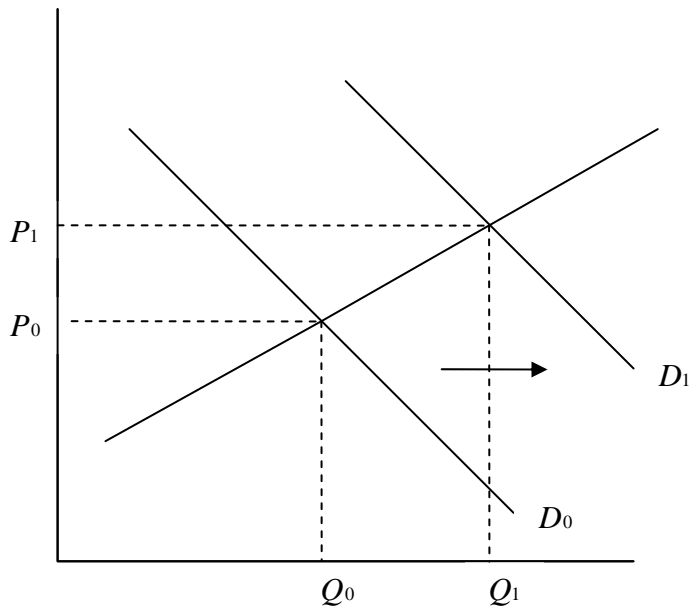

Figure 7: Equilibrium on a market with production quota

7a: Shift in the demand



7b: Shift in the supply



8a: shift in the demand

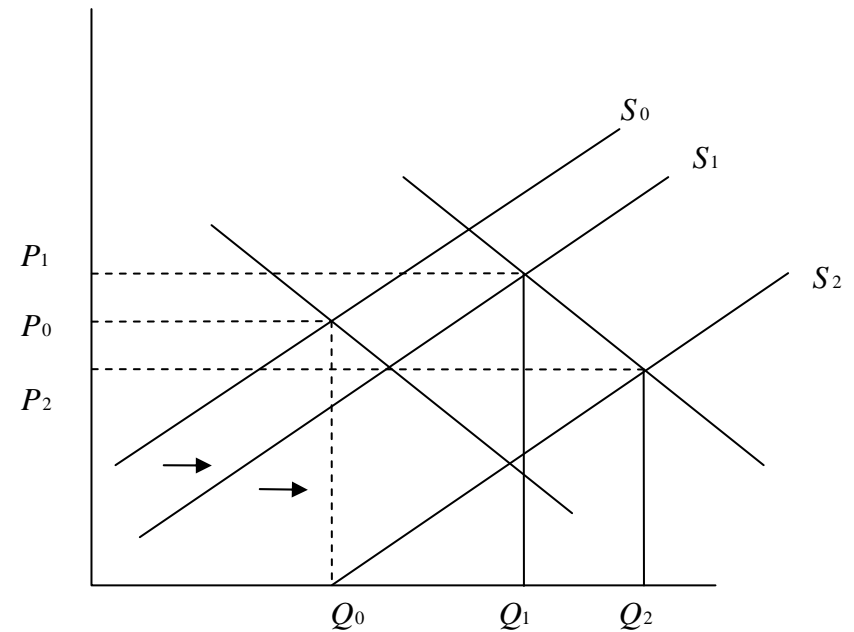

8b: shift in both supply and demand

Figure 8: Equilibrium on a market without production quota

2.2 Results of each scenarios

2.2.1 Baseline

In the baseline it is assumed that from 2008-09 to 2015-16 and beyond (2020-21), there is no change in the policy. Thus the only forces that play a role in the evolution of market equilibrium are exogenous changes in supply (technical change, changes in the prices of feed or beef) and in demand (global increase in the demand both in the EU and in the RoW).

With respect to milk supply, on average over the period 2008-2020, milk yields (autonomously) increase by 1.03% and 1.21% per annum for the EU15 and EU10 respectively. These yield increases, which vary over countries, are based on empirical estimates. As regard dairy products demand, trends were estimated. Over the 2008-2015 period, at the EU25 level, the annual increase in fat and protein demand is respectively 0.1% and 0.5%. The demand for imports in the RoW is assumed to increase by 2 % per year whatever the products.

At the EU level, the main element is the increase in the demand for protein which implies an increase in the SMP price (graph 1). In fact, as the SMP price at the beginning of the period is higher than the intervention price, all subsidies are equal to 0 (cf. Box 3). Then, the increase in demand induces an increase in the SMP price.

Graph 1 : Change in EU27 butter and SMP prices. Baseline scenario.

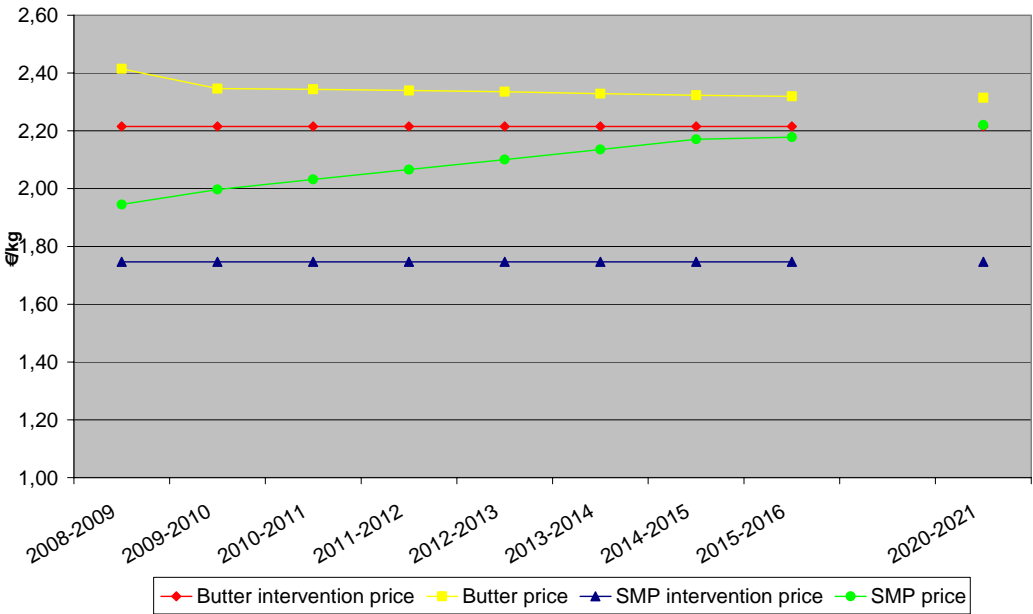

In the EU, the demand for butter decreases over time while the aggregate demand for fat marginally increases. At the beginning of the period the price of butter is greater than the intervention price. The decrease in butter demand generates a slight decrease in the domestic price of butter (Graph 1). As for SMP, it remains larger than the intervention price.

Thus both SMP and butter domestic prices are larger than the intervention price. The EU does not use any domestic or export subsidy to sustain domestic price of dairy products.

As a consequence of an increase in SMP price and a flat butter price, the farm milk price increases (about 1% a year). This increase in farm milk price induces an increase in the production of milk in countries for which the quota on milk production was not binding (Sweden, UK, EU10 countries, Bulgaria). The increase is small as it is about 0.1% a year at the EU level (Graph 2).

Graph 2 : Change in EU27 milk collected and in farm price of milk. Baseline scenario

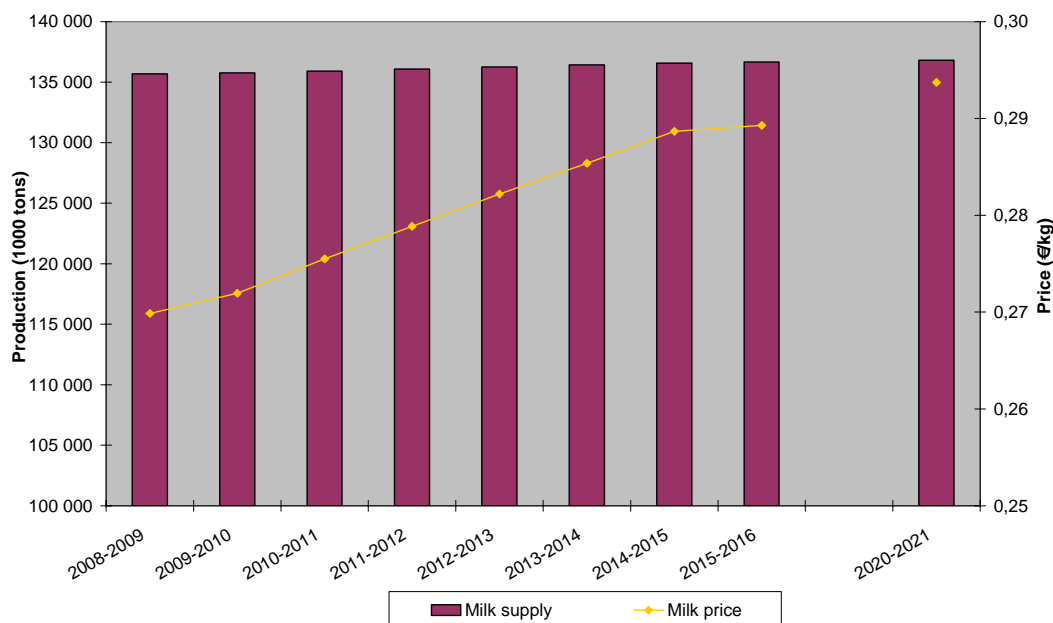

Both the increase in farm milk price and the technical change induce an increase in the quota rents in countries where quota is binding (Table 11).

Table 10: Change in milk collected production and quota rent between 2008-09 and 2015-16 in the European countries. Production in 1000 tons, rents in €/kg. Baseline scenario.

	Milk production 2008(*)	Milk production 2015	Variation 2015/2008 (%)	Quota rent 2008 (€/kg)	Quota rent 2015 (€/kg)
Belgium+Lux	3 347	3 347	0.0%	0.078	0.103
Denmark	4 522	4 522	0.0%	0.041	0.053
Germany	27 165	27 165	0.0%	0.027	0.059
Greece	760	760	0.0%	0.031	0.057
Spain	5 966	5 966	0.0%	0.121	0.130
France	23 357	23 357	0.0%	0.055	0.065
Ireland	5 277	5 277	0.0%	0.072	0.084
Italy	10 776	10 776	0.0%	0.091	0.089
Netherlands	10 892	10 892	0.0%	0.128	0.140
Austria	2 679	2 679	0.0%	0.085	0.109
Portugal	1 913	1 913	0.0%	0.037	0.014
Finland	2 436	2 436	0.0%	0.023	0.053
Sweden	3 104	3 250	4.7%	0.000	0.000
UK	13 746	14 012	1.9%	0.000	0.000

	Milk production 2008	Milk production 2015	Variation 2015/2008 (%)	Quota rent 2008 (€/kg)	Quota rent 2015 (€/kg)
Czech Republic	2 706	2 735	1.1%	0.000	0.016
Hungary	1 760	1 970	11.9%	0.000	0.012
Poland	8 991	9 122	1.5%	0.000	0.020
EU7	4 182	4 342	3.8%	0.000	0.000
Bulgaria	861	889	3.2%		
Romania	1 251	1 251	0.0%		
EU27	135 694	136 663	0.7%	0.047	0.061

(*) Note that milk production corresponds to the production of milk at the actual level of fat for each country. When the fat content is higher than the reference one, then the fat correction of quota applies.

The change in the price of protein (partly compensated by the decrease in fat price) induces an increase in the price of dairy products in the EU (Table 12, and Annex). However, due to the positive trend in their demand, the consumption of cheese and fresh products increases. On the contrary, the consumption of liquid milk decreases. The other consequence of the combination of an increase in the demand for dairy products in the EU and a stagnation of production due to the quota system is a decrease in the EU exports of dairy products (EU exports in fat and protein equivalent decrease by 11% and 14% respectively). This arises while we assume a growing demand in the world.

Table 11: Changes in production, consumption, prices and exports of dairy products in the EU27. Production, consumption and exports in 1000 tons, price in €/kg. Baseline scenario.

		2008	2015	Change
Liquid milk	Production	32990	32039	-2.9%
	Consumption	32872	31921	-2.9%
	Exports	-	-	-
	Price	0.386	0.406	5.1%
Butter	Production	1837	1759	-4.3%
	Consumption	1761	1712	-2.8%
	Exports	147	117	-20.4%
	Price	2.415	2.320	-3.9%
Skim milk powder	Production	953	812	-14.8%
	Consumption	756	717	-5.2%
	Exports	271	169	-37.6%
	Price	1.945	2.178	12.0%
Whole milk powder	Production	906	869	-4.1%
	Consumption	466	478	2.5%
	Exports	443	394	-11.1%
	Price	2.156	2.314	7.3%
Cheese	Production	8547	9017	5.5%
	Consumption	8117	8584	5.8%
	Exports	603	605	0.4%
Of which: Semi hard cheese	Production	2630	2799	6.4%
	Consumption	2421	2606	7.6%
	Exports	303	287	-5.1%
	Price	3.016	3.237	7.3%
Aggregated exports	Fat equivalent	363	324	-10.8%
	Protein equivalent	422	362	-14.4%

In the model, we distinguish 6 different cheeses (soft, semi-hard, hard, blue, fresh and processed) which are aggregated under the term 'cheese'. We report the results for semi-hard cheese to provide the changes in price.

2.2.2 Scenario 1: Phasing out quota - Q1

In scenario Q1, quota are increased by 1% a year from 2009-10 to 2014-15 and are then removed in 2015-2016. During the phasing out quota period, the EU milk production increases by about 0.66% a year.

- In a first group of countries (Austria, Belgium, Ireland, Italy, Netherlands and Spain), quotas remain binding in 2014-15 as the increase in production is equal to the increase in quota with the exception of Italy and Austria where the increase in production is lower than the increase in quota as it was assumed that part of the additional quota was used to cover the over-production.
- In a second group of countries (Denmark, France, Germany, Greece, Poland, Portugal, Finland, Sweden, UK, EU7, Hungary, Czech Republic, as well as Bulgaria and Romania), the quota is no longer binding in 2014-15 as the increase in production is lower than the increase in quota. In Hungary, the increase in production is larger as the quota was not binding in 2008-09 and is no longer binding in 2014-15. It should be noted that in UK, the production decreases. This is due to the increase in production in the other countries which has a negative impact on the farm milk price. This price decrease causes a decrease in UK production as the quota rent was equal to 0 in UK at the beginning of the period. The rate of technical change (which lowers marginal costs) is not sufficient to dominate the impact of the drop in price.

Table 12 : Change in the milk collected production in the European countries and change in quota rents. Production in 1000 tons, rents in €/kg. Scenario Q1.

	Milk production 2008	Milk production 2014	Variation 2014/2008	Quota rent in 2014 (€/kg)	Milk production 2015	Variation 2015/2014
Belgium+Lux	3347	3551	6.0%	0.037	3673	3.4%
Denmark	4522	4764	5.3%	0.000	4742	-0.5%
Germany	27165	28561	5.1%	0.000	28458	-0.4%
Greece	760	786	3.4%	0.000	783	-0.3%
Spain	5966	6328	6.0%	0.061	6624	4.7%
France	23357	24737	5.9%	0.000	24620	-0.5%
Ireland	5277	5594	6.0%	0.030	5751	2.8%
Italy	10776	11092	2.9%	0.046	11392	2.7%
Netherlands	10892	11551	6.0%	0.090	12718	10.0%
Austria	2679	2778	3.7%	0.060	2925	5.3%
Portugal	1913	1926	0.7%	0.000	1899	-1.4%
Finland	2436	2552	4.8%	0.000	2539	-0.5%
Sweden	3104	3146	1.3%	0.000	3135	-0.4%
UK	13746	13660	-0.6%	0.000	13581	-0.6%
Czech Republic	2706	2706	0.0%	0.000	2701	-0.2%
Hungary	1760	1902	8.0%	0.000	1923	1.1%
Poland	8991	9067	0.8%	0.000	9082	0.2%
EU7	4182	4219	0.9%	0.000	4218	-0.1%
Bulgaria	861	882	2.4%		875	-0.8%
Romania	1251	1293	3.3%		1281	-0.9%
EU27	135694	141097	4.0%	0.019	142921	1.3%

In Austria and Italy, we assume that the increase in quota is partly used for a decrease in the over-production.

Removing quota in 2015 leads to a 1.3 % increase of EU27 production in 2015-16. It is likely that the following years the production will also adapt to the absence of quota. However, before removing quota, the quota rent was very small (0.02 €/kg in average). Then, removing quota cannot be considered as a huge change. In volume, the increase in production in 2015-16 is mainly the consequence of an increase in the milk production in The Netherlands. However production also increases in Belgium, Spain, Ireland, Italy, Austria, and Hungary. Conversely, the production remains roughly stable or even decreases in countries like France, Germany and the United Kingdom. In EU12 countries, the production is roughly stable.

After the relative shock on production due to the quota removal, the production increases slightly in response to both the evolution of demand (trend) and supply (technical progress).

During the ‘soft landing’ period, the farm milk price remains roughly stable (it first decreases and then increases) as the increase in demand roughly compensates the increase in production. During the quota removal period, farm milk price decreases while it slightly increases later (Graph 3).

Graph 3: Change in EU27 milk collected and in farm price of milk. Scenario Q1.

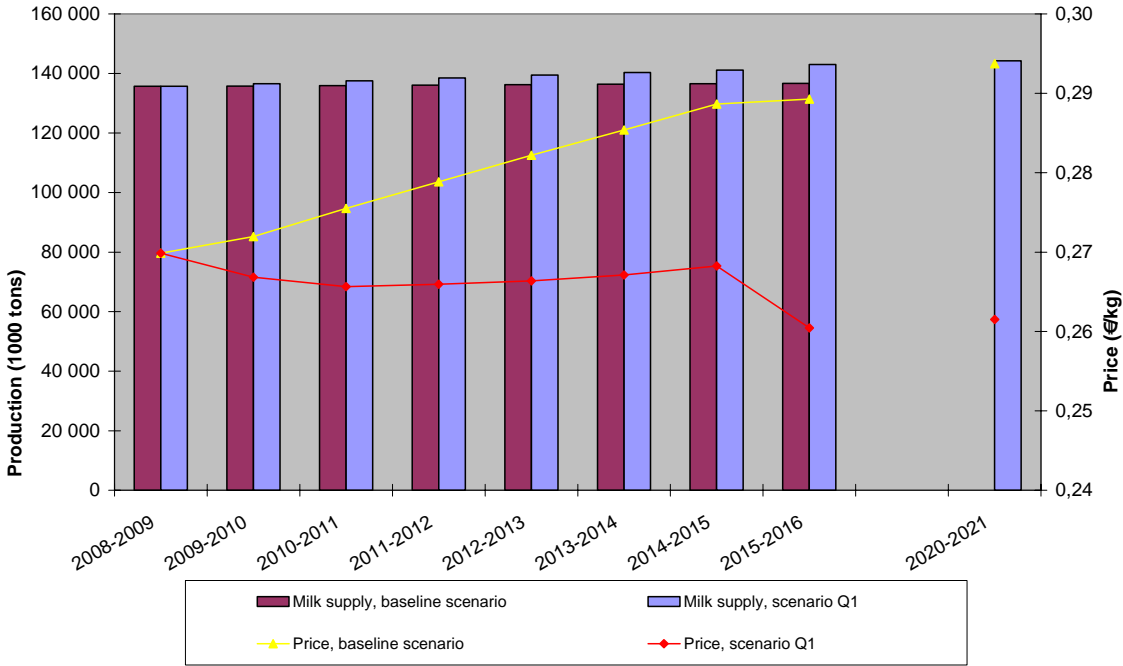

Table 13 : Difference in milk production and price between scenario Q1 and Baseline

	2010	2014	2015
Production	1,2%	3,3%	4,6%
Price	-3,6%	-7,0%	-9,8%

The difference in farm milk price between scenario Q1 and Baseline increases over time in response to the increase in the difference of production. When both butter and SMP prices can adjust (2010), a 1% difference in production induces a -3% difference in price. When only the SMP price can adjust a 1% difference in production induces a -2% difference in farm milk price.

During the ‘soft landing’ period, SMP price increases as the demand for protein increases at a higher rate than the production. The rate of increase is lower than in Baseline. The SMP price remains significantly higher than the intervention price. Removing quota in 2015-16 causes a temporary

decrease in the SMP price as the increase in production of protein is larger than the increase in demand. After this 'choc' the protein price remains roughly stable. The SMP price is still larger than the intervention price (Graph 4).

Graph 4 : Change in SMP price and production. Scenario Q1 compared to baseline scenario.

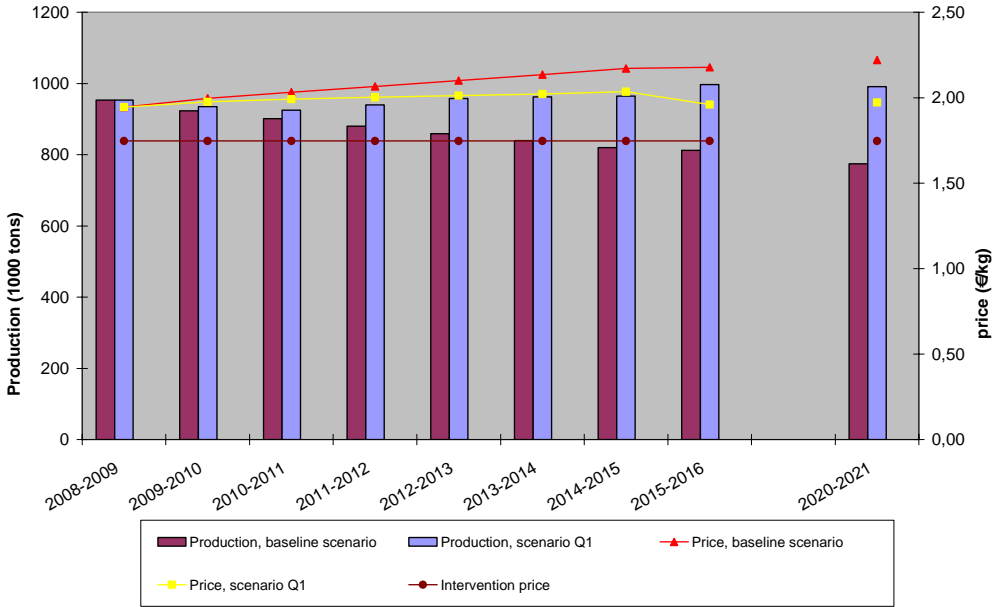

Because more fat is produced and because growth of fat demand is small, butter price decreases under this scenario. However, the decrease is relatively small as butter price reaches the intervention price in 2011-12. Thus, from this date to the end of the simulation period, policy measures are needed to sustain butter price. To do so, export subsidies are introduced to maintain the domestic price of butter equal to the (effective) intervention price (Graph5).¹⁶

Graph 5 : Change in butter price and per unit export subsidy. Scenario Q1 compared to baseline.

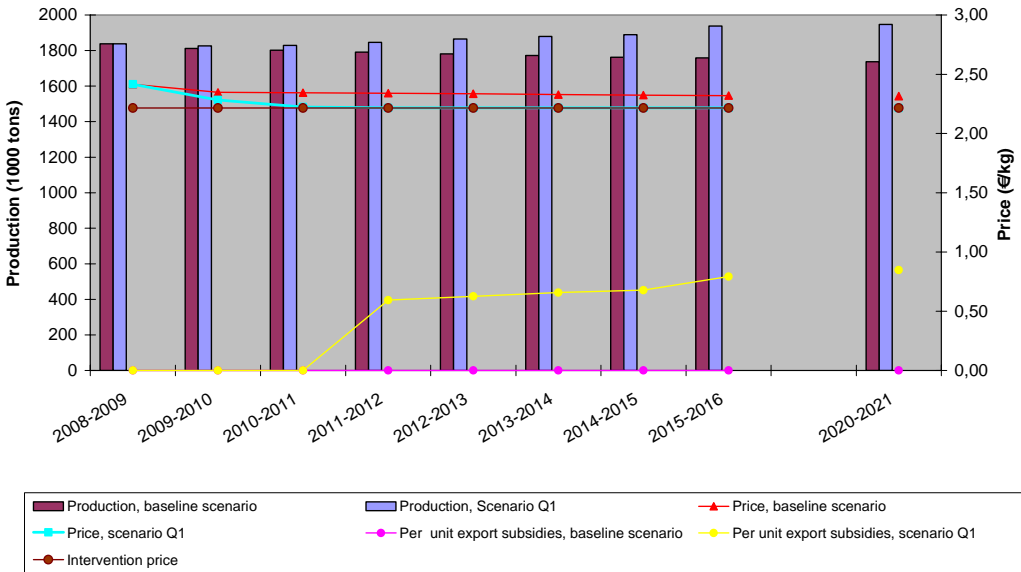

¹⁶ Note that after quota abolition, the EU also uses some domestic subsidies to support the butter price. The per-unit value of this subsidy is significantly lower than the per unit export subsidy.

As compared to baseline, prices of dairy products are slightly lower, by 4 to 6% in 2014 and by 5 to 10% in 2015 after removing quota (Table 15). Due to lower prices, there is some additional consumption. But the increase in consumption due to the price decrease is marginal. Then, the increase in milk production is mainly exported on world markets (Table 16). At the end of the period, more than 70% of the additional production is exported on the world markets.

Table 14 : EU27. Comparison of production, consumption, exports and prices of dairy products between Baseline and Scenario Q1. Production, consumption and exports are in 1000 tons, prices in €/kg.

		2014			2015		
		Baseline	Q1	Change	Baseline	Q1	Change
Liquid milk	Production	32109	32372	0,8%	32039	32416	1,2%
	Consumption	31992	32254	0,8%	31921	32299	1,2%
	Price	0,41	0,39	-4,3%	0,41	0,38	-6,3%
Butter	Production	1762	1888	7,1%	1759	1934	10,0%
	Consumption	1716	1741	1,5%	1712	1737	1,5%
	Exports	117	218	86,3%	117	268	129,1%
	Price	2,32	2,22	-4,6%	2,32	2,22	-4,5%
Skim milk powder	Production	820	964	17,6%	812	993	22,3%
	Consumption	718	741	3,2%	717	753	5,0%
	Exports	176	297	69,1%	169	315	85,9%
	Price	2,17	2,04	-6,2%	2,18	1,97	-9,7%
Whole milk powder	Production	875	1025	17,2%	869	1085	24,9%
	Consumption	477	484	1,6%	478	488	2,2%
	Exports	401	544	35,6%	394	600	52,3%
	Price	2,31	2,19	-5,3%	2,31	2,14	-7,3%
Cheese	Production	8989	9097	1,2%	9017	9163	1,6%
	Consumption	8552	8600	0,6%	8584	8651	0,8%
	Exports	610	670	9,7%	605	685	13,2%
Of which Semi hard cheese	Production	2793	2865	2,6%	2799	2899	3,6%
	Consumption	2594	2613	0,8%	2606	2635	1,1%
	Exports	293	346	17,9%	287	358	24,6%
	Price	3,23	3,06	-5,4%	3,24	2,98	-7,8%
Aggregated exports	Protein equivalent	368	474	29,0%	362	509	40,6%
	Fat equivalent	327	464	41,6%	324	524	61,6%

Table 15 : Percent of the additional production exported on world markets

	2010	2014
Fat	44,3%	78,4%
Protein	69,7%	70,3%

On graph 6 we represent the change in producer surplus as compared to the baseline scenario. As regards producers' surplus associated with scenario Q1 there are two relevant factors. On the one hand, production increases which positively affects the producers' surplus. However, at the same time the farm gate price of milk declines, which negatively affects producers' surplus. The negative impact of the price decline clearly dominates the quantity increase effect, resulting in a net decline of producer surplus from 0.7 billion euro in 2009 till 4.2 billion euro in 2015. The net present value of the losses in producer surplus over the period 2009-2015 is equal to 11.5 billion euro. This total producers'

surplus loss over the period 2008-2015 comes down to an annual equivalent loss of 1.9 billion euro per annum.

The main factor behind this loss in producers' surplus is the strong decline in milk quota rents. After 2015 the producers' surplus stabilizes and starts to gradually increase, due to the slightly increasing milk price. Since the direct payments are decoupled from production and similar for all scenarios, these do not affect the change in producers' surplus.

The decrease in producers' surplus integrates the decrease in quota rents as well as price effects. Because quota, which corresponds to a 'right to produce', is an asset, the decrease in quota rent will affect the value of this asset. This means that part of the loss of surplus will be borne by owners of quota who are not always the producers. The relative share of loss that is borne by dairy producers rather than owners is variable among countries. It depends, among other elements, how the market for quota is organized, if any.

Graph 6 : Change in EU27 producer surplus in Scenario Q1 as compared to baseline.

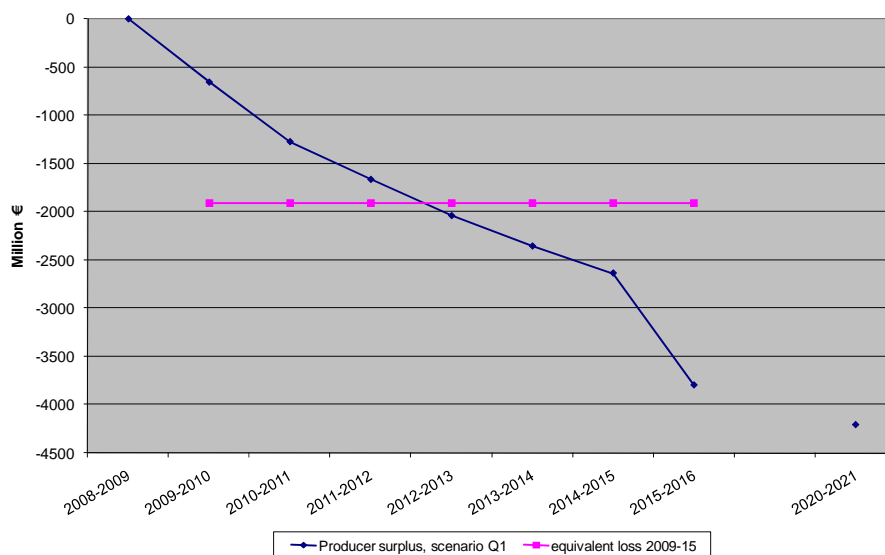

Graph 7 Change in total taxpayer revenues in scenario Q1.

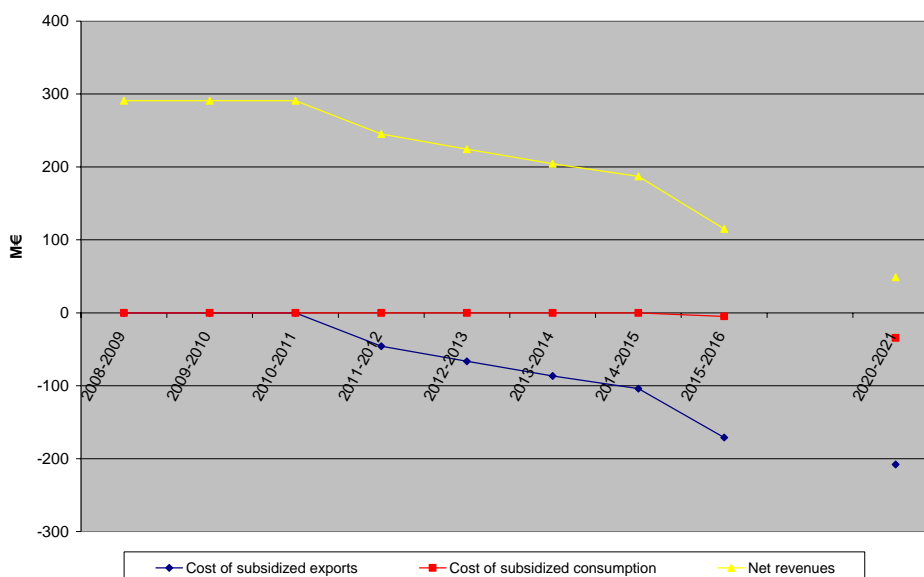

From 2011-12 to the end of the simulation period, the EU uses export subsidies to sustain the domestic butter price. The EU also uses some domestic subsidies to sustain butter price after quota removal. The cost to sustain the butter price in 2015-16 is about 190 M€ which is lower than the revenues from the import taxes. Thus the net revenue for the taxpayer decreases over the period from 290 M€ in 2008-09 to 100 M€ in 2015-16 and about 50 M€ in 2020-21.¹⁷

EU consumers gain from the decrease in dairy products prices. In average, over the period 2009 to 2015, the gain for EU25 consumers is about 1.8 billion € per annum.

On the whole, as compared to Baseline, the welfare impact of the scenario is:

- A small and negative change in the total welfare
- A significant transfer of surplus from producers to the benefit of consumers
- An increase in the surplus of the processing sector that originates from the increase in the processing activity.¹⁸
- A small negative impact on taxpayer.

Graph 8 Change in EU25 consumer surplus in scenario Q1¹⁹

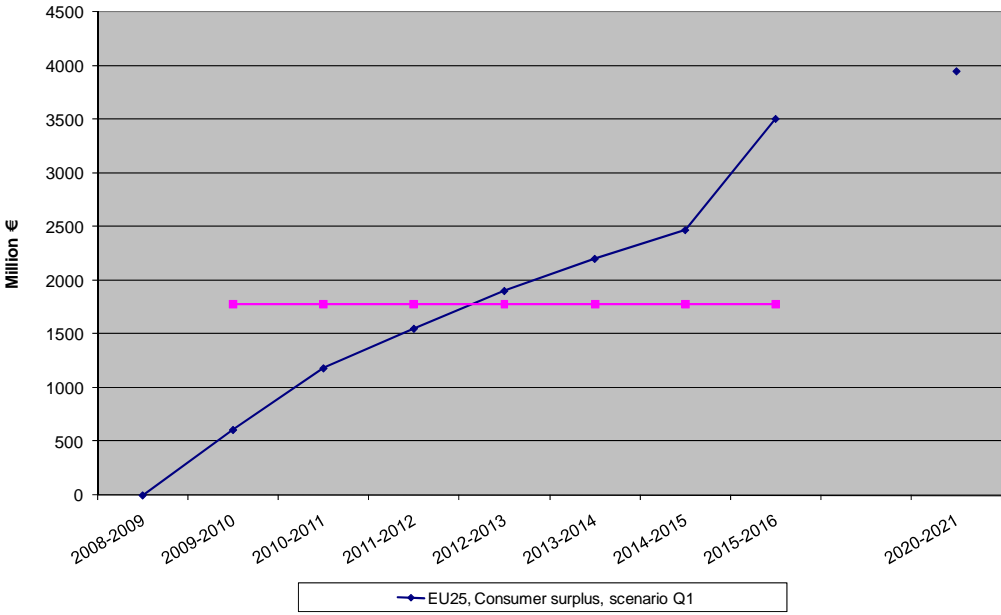

¹⁷ The revenues do not include revenues from payments of super-levy from the over-fulfilment that was considered in Italy, Austria and Germany.

¹⁸ The increase in processors surplus is not quantified as it comes from changes in marginal costs of processing as well as changes in the margins that could exist on differentiated products. The level of these margins is not known precisely which explain the absence of quantification of the surplus.

¹⁹ Note that the consumer surplus is determined on EU25 countries due to the simplified way Bulgaria and Romania consumption of dairy products is modeled.

2.2.3 Scenario 2: Phasing out quota – Q2

In scenario Q2, quota are increased by 2% a year from 2009-10 to 2014-15 and then removed in 2015-2016. This scenario is thus similar to the previous one except that the potential increase in production during the ‘soft landing’ phase is larger.

During the phasing out quota period, the EU milk production increases by about 0.83% a year. We can distinguish two groups of countries:

- In a first group of countries (Austria, Netherlands and Spain), the quotas remain binding in 2014-15 as the increase in production is equal to the increase in quota. However, the quota rents are rather low except in the Netherlands.
- In a second group of countries (all other countries), the quota is no longer binding in 2014-15 as the increase in production is lower than the increase in quota. It should be noted that in Portugal, UK and Czech Republic the production decreases. This is due to the increase in production in the other countries which has a negative impact on the farm milk price. This price decrease causes a decrease in UK and Czech Republic productions as the quota rent was equal to 0 at the beginning of the period. The rate of technical change (which lowers marginal costs) is not sufficient to dominate the impact of the drop in price. For Portugal the same mechanism applies even though at the beginning of the period the quota rent was positive.

Table 16 : Change in the milk collected production in the European countries and change in quota rents. Production in 1000 tons, rents in €/kg. Scenario Q2.

	Milk production 2008	Milk production 2014	Variation 2014/2008	Quota rent in 2014 (€/kg)	Milk production 2015	Variation 2015/2014
Belgium+Lux	3347	3700	10,6%	0,000	3699	0,0%
Denmark	4522	4736	4,7%	0,000	4720	-0,3%
Germany	27165	28329	4,3%	0,000	28340	0,0%
Greece	760	782	2,9%	0,000	782	0,0%
Spain	5966	6690	12,1%	0,002	6712	0,3%
France	23357	24634	5,5%	0,000	24557	-0,3%
Ireland	5277	5846	10,8%	0,000	5836	-0,2%
Italy	10776	11534	7,0%	0,000	11577	0,4%
Netherlands	10892	12209	12,1%	0,054	12997	6,5%
Austria	2679	2942	9,8%	0,009	2979	1,3%
Portugal	1913	1910	-0,2%	0,000	1890	-1,1%
Finland	2436	2527	3,7%	0,000	2527	0,0%
Sweden	3104	3120	0,5%	0,000	3122	0,1%
UK	13746	13556	-1,4%	0,000	13529	-0,2%
Czech Republic	2706	2684	-0,8%	0,000	2686	0,1%
Hungary	1760	1886	7,1%	0,000	1909	1,3%
Poland	8991	9041	0,6%	0,000	9062	0,2%
EU7	4182	4187	0,1%	0,000	4196	0,2%
Bulgaria	861	874	1,4%		874	0,0%
Romania	1251	1279	2,3%		1279	-0,1%
EU27	135694	142466	5,0%	0,005	143274	0,6%

In Austria and Italy, we assume that the increase in quota is partly used for a decrease in the over-production.

The evolution of milk production is ‘smoother’ than in Scenario Q1. In particular, removing quota at the end of the period of quota induces a small increase in production comparable to the average increase observed during the soft landing period. In most countries, the production in the year of quota abolition (2015) is very similar to the production in the last year with quotas (2014). Similarly

farm milk price evolution is rather smooth meaning that there is no sharp drop upon quota removal. It is also worth to mention that the market situation at the end of the period of analysis (2020) is equivalent to the one observed in the previous case (Q1).

Graph 9 : Change in EU27 collected production and price of milk. Scenario Q2.

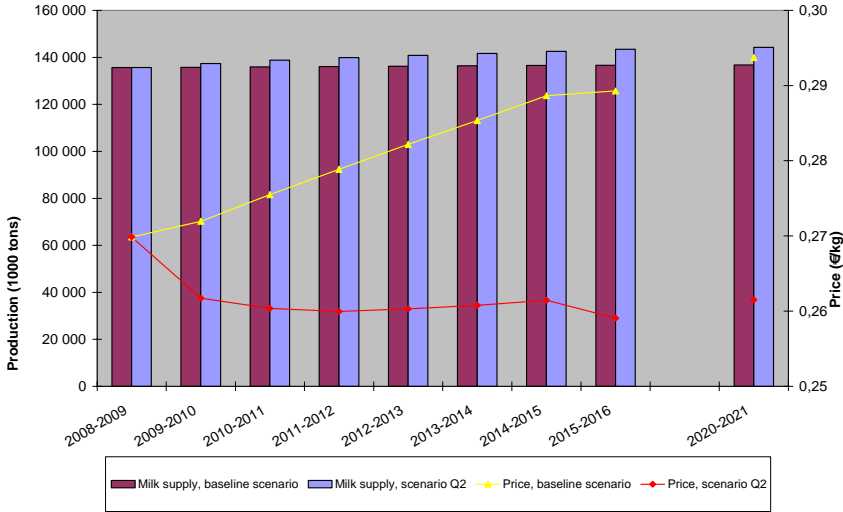

Table 17 : Difference in milk production and price between scenario Q2 and Baseline

	2010	2014	2015
Production	2,1%	4,3%	4,8%
Price	-5,5%	-9,2%	-10,3%

The difference in farm milk price between scenario Q2 and Baseline increases over time in response to the increase in the difference of production. When both butter and SMP prices can adjust (2010), a 1% difference in production induces a -3% difference in price. When only the SMP price can adjust a 1% difference in production induces a -2% difference in farm milk price.

During the phasing out period, SMP price remains roughly stable as the demand for protein increases at a similar rate than the production. The SMP price remains significantly higher than the intervention price. No subsidies are needed to sustain the price of protein in the EU.

Graph 10 : Change in SMP price and per unit export subsidy. Scenario Q2 compared to baseline.

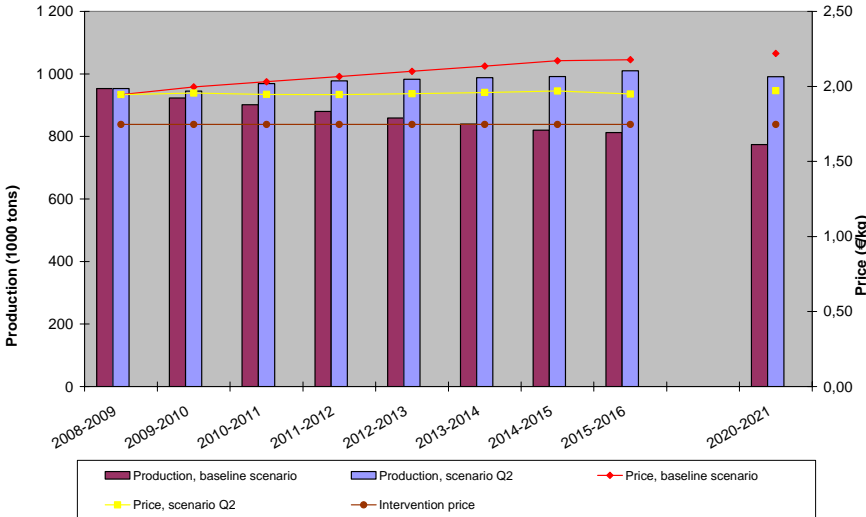

Because more fat is produced and because fat demand increases slowly, butter price decreases under this scenario. However, the decrease is relatively small as butter price reaches the intervention price in 2009-10. Thus from this date to the end of the simulation period, policy measures are needed to sustain butter price. To do so, export subsidies are introduced to maintain the domestic price of butter equal to the (effective) intervention price. As compared to Q2, export subsidies are slightly higher but the difference vanishes at the end of the period.²⁰

Graph 11 : Change in butter price and per unit export subsidy. Scenario Q2 compared to baseline.

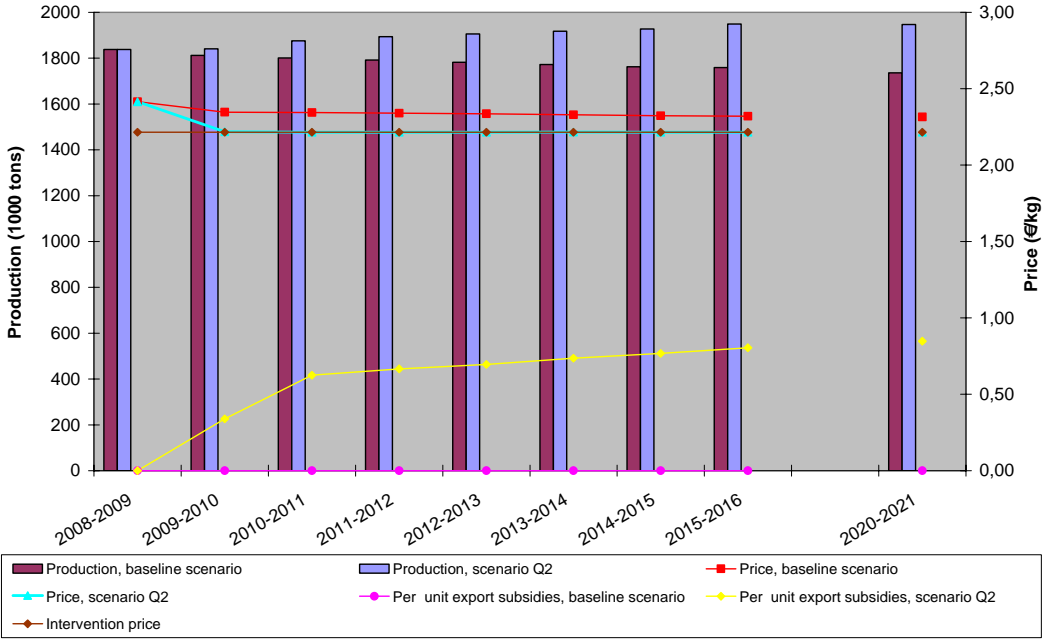

As compared to baseline, prices of dairy products are slightly lower, by 5 to 9% in 2014 and by 5 to 11% in 2015 after removing quota. Due to lower prices, there is some additional consumption. But the increase in consumption due to the price decrease is marginal. Then, the increase in milk production is mainly exported on world markets as more than 70% of the additional production (compared to baseline) is exported on world markets.

²⁰ Note that after quota abolition, the EU also uses some domestic subsidies to support the butter price. The per-unit value of this subsidy is significantly lower than the per unit export subsidy.

Table 18 : Comparison of production, consumption, exports and prices of dairy products between Baseline and Scenario Q2. Production, consumption and exports are in 1000 tons, prices in €/kg

		2014			2015		
		Baseline	Q2	Change	Baseline	Q2	Change
Liquid milk	Production	32109	32469	1,1%	32039	32437	1,2%
	Consumption	31992	32351	1,1%	31921	32320	1,2%
	Price	0,41	0,38	-6,0%	0,41	0,38	-6,6%
Butter	Production	1762	1924	9,2%	1759	1943	10,5%
	Consumption	1716	1741	1,5%	1712	1738	1,5%
	Exports	117	254	117,1%	117	275	135%
	Price	2,32	2,22	-4,6%	2,32	2,22	-4,5%
Skim milk powder	Production	820	989	20,7%	812	1003	23,4%
	Consumption	718	751	4,6%	717	755	5,2%
	Exports	176	312	77,8%	169	322	90,3%
	Price	2,17	1,98	-9,0%	2,18	1,95	-10,3%
Whole milk powder	Production	875	1081	23,5%	869	1091	25,6%
	Consumption	477	486	2,1%	478	489	2,3%
	Exports	401	597	48,8%	394	605	53,6%
	Price	2,31	2,15	-6,8%	2,31	2,14	-7,7%
Cheese	Production	8989	9121	1,5%	9017	9180	1,8%
	Consumption	8552	8614	0,7%	8584	8654	0,8%
	Exports	610	680	11,4%	605	699	15,5%
Of which: Semi hard cheese	Production	2793	2881	3,1%	2799	2914	4,1%
	Consumption	2594	2621	1,0%	2606	2637	1,2%
	Exports	293	354	20,7%	287	371	29,2%
	Price	3,23	2,99	-7,4%	3,24	2,97	-8,3%
Aggregated exports	Protein equivalent	368	505	37,3%	362	517	42,9%
	Fat equivalent	327	510	55,8%	324	535	65,0%

Table 19 : Percent of the additional production exported on world markets

	2010	2014
Fat	63,1%	78,5%
Protein	71,2%	70,3%

As regards the welfare effects, for scenario Q2 more or less the same holds as for scenario Q1. As a consequence of that initially the milk price decline is sharper than in Q1, the producers' surplus declines more strongly, at least in the initial years under Q2.

The net present value of the losses in producer surplus over the period 2009-2015 is equal to 15.5 billion euro (compared to baseline). This total producers' surplus loss over the period 2009-2015 comes down to an annual equivalent loss of 2.6 billion euro per annum.

Graph 12 : Change in the EU27 producer surplus as compared to baseline.

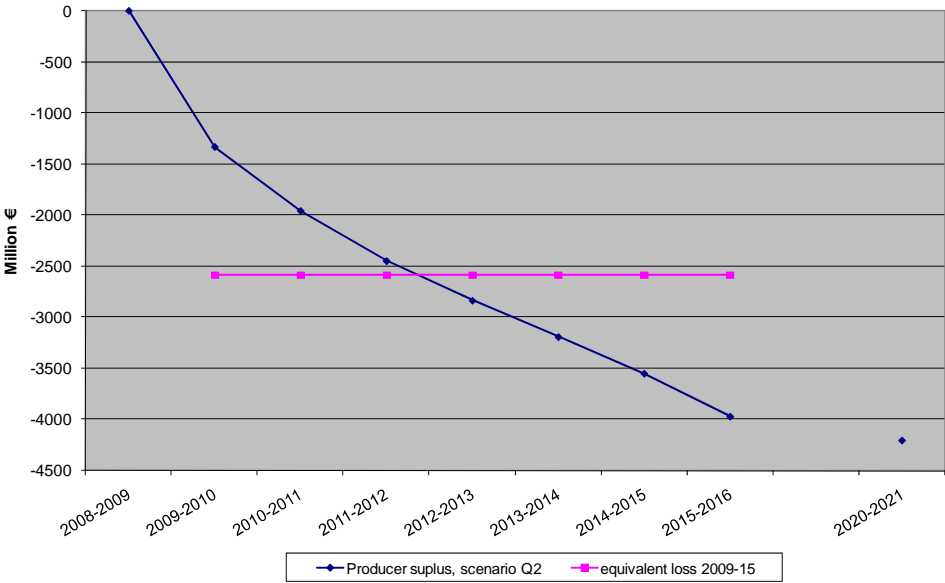

As stated for scenario Q1, the only change in taxpayer revenue is the cost to sustain butter price through the utilization of export subsidies (and marginally domestic subsidies) which amount to about 200 million Euros at the end of the period.

Graph 13 : Change in taxpayer revenues in scenario Q2.

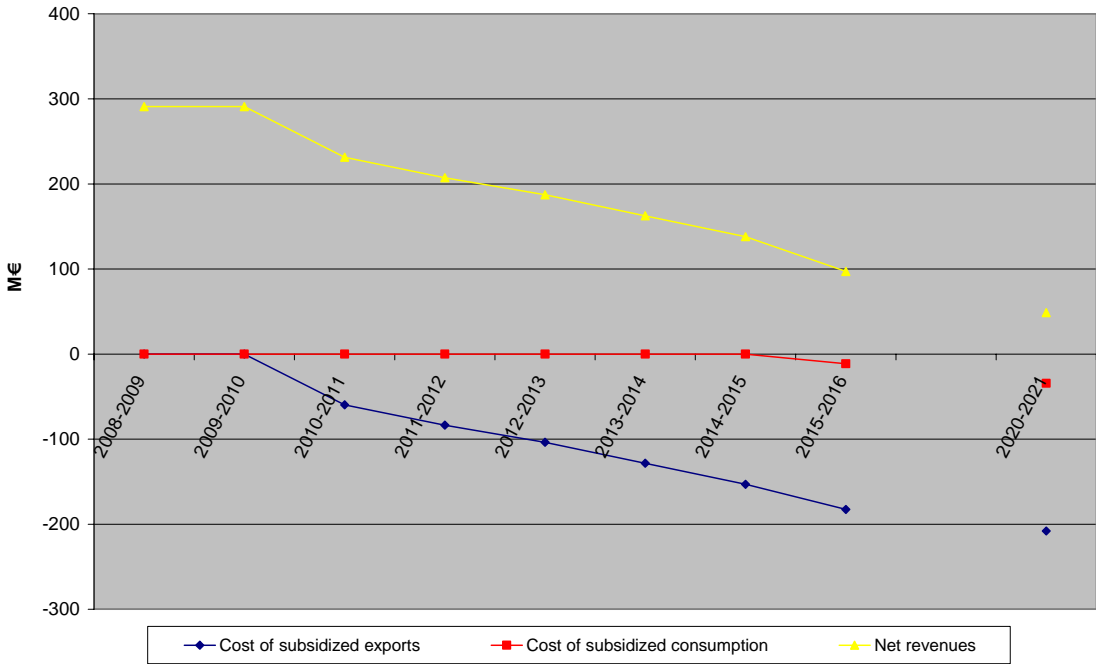

Graph 14 : Change in EU25 consumer surplus scenario Q2.

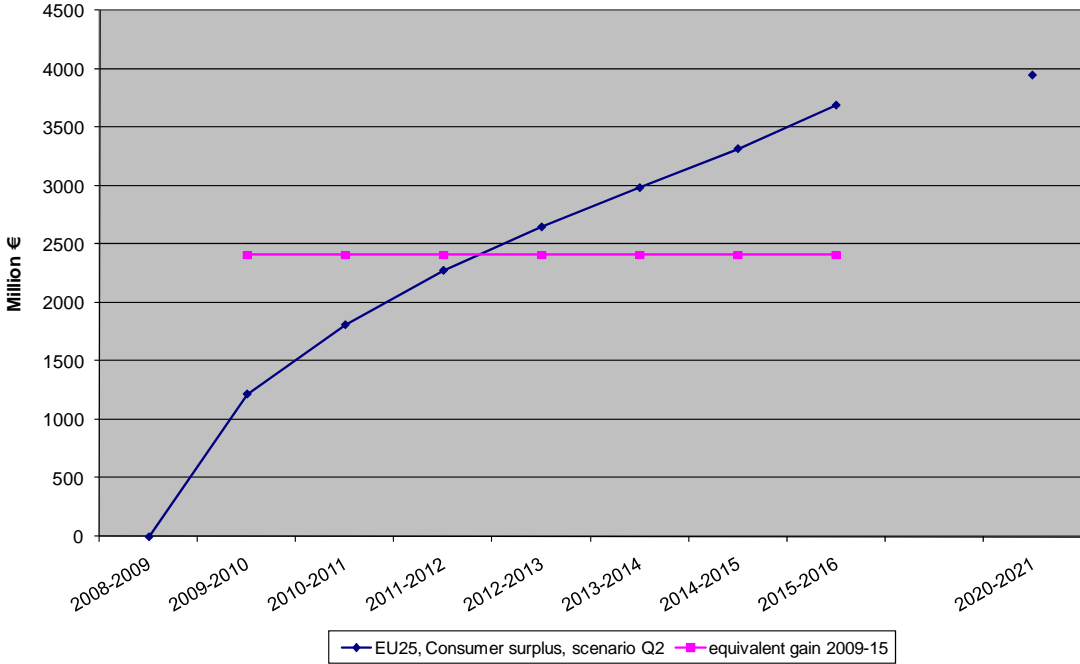

EU consumers gain from the decrease in dairy products prices. In average, over the period 2009 to 2015, the gain for EU25 consumers is about 2.4 billion € per annum.

On the whole, as compared to Baseline, the welfare impact of the scenario is:

- A small and negative change in the total welfare
- A significant transfer of surplus from producers to the benefit of consumers
- An increase in the surplus of the processing sector which originates from the increase in processing activities.
- A small negative impact on taxpayer.

2.2.4 Scenario 3: Removing quota in 2009

Removing quota causes a significant increase in milk supply. The first two years the milk supply increases by roughly 6 million tons and 2 million tons. This is because in a lot of countries, production was restricted by quotas. However, this causes a significant decrease in the raw milk price which decreases by 7% the first year after the removal and by an additional 1% during the second year. Note however that the second year the decrease in farm milk price is small. This is because the butter price reaches the intervention price in 2009-10 and cannot decrease more. This is transmitted to the farm milk price.

After this period of adaptation of production, the increase in production is lower and mainly due to the increase in demand.²¹ This later increase in production is accompanied by a price increase. Again the increase in farm milk price is small as it is only due to the increase in the protein price while the fat price remains sustained (through the intervention price of butter).

Graph 15 : Change in EU27 milk collected and in farm price of milk. Scenario QR-09 compared to Baseline.

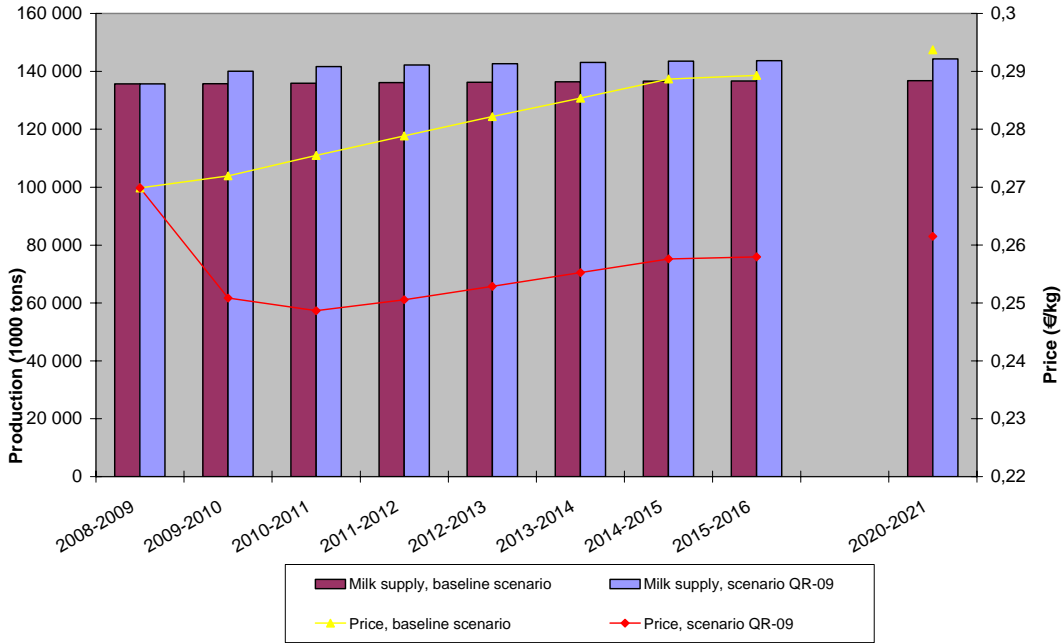

Table 20: Difference in milk production and price between scenario QR-09 and Baseline

	2010	2014	2015
Production	4,1%	5,0%	5,0%
Price	-9,6%	-10,6%	-10,6%

The difference in farm milk price between scenario QR-09 and Baseline is about 10%. As butter price can only partly adjust (due to the intervention price) a 1% difference in production induces a -2% difference in farm milk price.

²¹ It should be noted that the model implicitly assumes that the new equilibrium is quickly reached - in two years in fact (producers perfectly anticipate the new prices, they are able to increase significantly and quickly their level of production, markets converge to the new equilibrium).

If the EU27 production is increased by 4.3% from 2008-09 to 2010-11, the increase in production is not evenly shared. In some countries, the increase of production is quite significant (Spain, Netherlands, Ireland, Austria, Belgium) while in other countries there is a decrease in the level of production due to the price effect (Sweden, UK, EU12 except Hungary).

From 2010-11 to 2015-16, the EU27 increase in production is relatively small (+1.5% over the 5 years) and is more evenly shared among countries.

Table 21 : Change in the milk collected production in the European countries and change in quota rents. Production in 1000 tons, rents in €/kg. Scenario QR-09.

	Milk production 2008	Quota rent in 2008(€/kg)	Milk production 2010	Variation 2010/2008	Milk production 2015	Variation 2015/2010
Belgium+Lux	3347	0,078	3625	8,3%	3693	1,9%
Denmark	4522	0,041	4657	3,0%	4698	0,9%
Germany	27165	0,027	27564	1,5%	28253	2,5%
Greece	760	0,031	771	1,4%	781	1,3%
Spain	5966	0,121	6665	11,7%	6710	0,7%
France	23357	0,055	24397	4,5%	24506	0,4%
Ireland	5277	0,072	5748	8,9%	5819	1,2%
Italy	10776	0,091	11575	7,4%	11583	0,1%
Netherlands	10892	0,128	13184	21,0%	13560	2,9%
Austria	2679	0,085	2926	9,2%	2990	2,2%
Portugal	1913	0,037	1940	1,4%	1883	-2,9%
Finland	2436	0,023	2461	1,0%	2518	2,3%
Sweden	3104	0,000	3038	-2,2%	3113	2,5%
UK	13746	0,000	13391	-2,6%	13495	0,8%
Czech Republic	2706	0,000	2644	-2,3%	2675	1,2%
Hungary	1760	0,000	1775	0,8%	1895	6,7%
Poland	8991	0,000	8950	-0,5%	9044	1,1%
EU7	4182	0,000	4102	-1,9%	4177	1,8%
Bulgaria	861		840	-2,5%	872	3,8%
Romania	1251		1228	-1,9%	1276	4,0%
EU27	135694	0,047	141481	4,3%	143539	1,5%

The price of butter drops when quotas are removed. However, the butter price quickly reaches the intervention price. Then thanks to an increase in subsidies (mainly export subsidies but in some extent domestic subsidies), the domestic price of butter is sustained at the level of intervention price. Similarly, the SMP price drops. However, the SMP price remains larger than the intervention price and there is no need to use subsidies to sustain the domestic price of SMP.

Graph 16 : Change in butter price and per unit export subsidy. Scenario QR-09 compared to baseline.

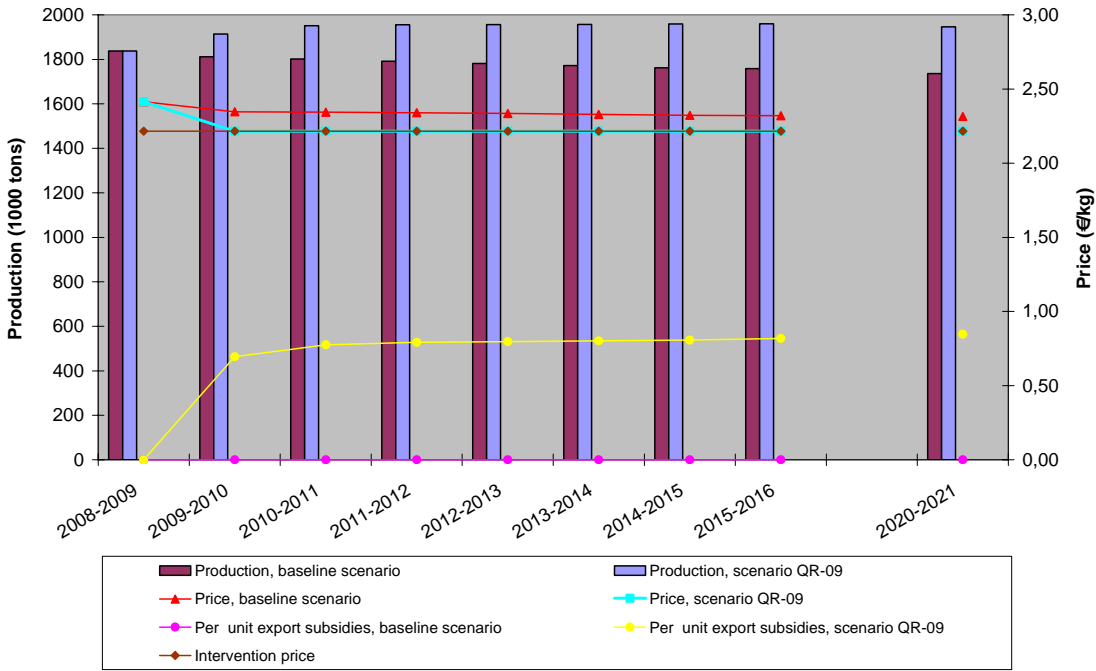

Graph 17 : Change in SMP price and production. Scenario QR-09 compared to Baseline.

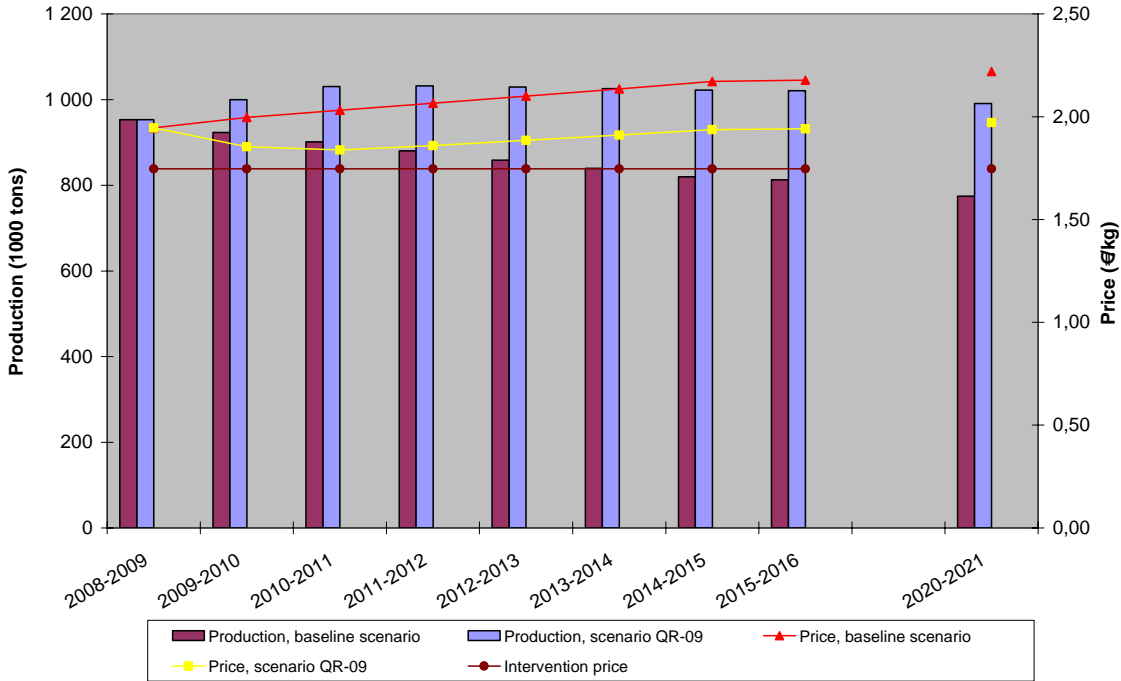

As compared to baseline, prices of dairy products are lower, by 6 to 10% in 2010 and by 5 to 11% in 2015. Due to lower prices, there is some additional consumption. But the increase in consumption due to the price decrease is marginal. Then, the increase in milk production is mainly exported on world markets. This is particularly true for butter thanks to the export subsidies. As stated for Q1 and Q2,

most of the additional production (compared to baseline) about 70% to 80% of the additional fat and protein production is exported on world markets (Table 24).

Table 22 : Comparison of production, consumption, exports and prices of dairy products between Baseline and Scenario QR-09. Production, consumption and exports are in 1000 tons, prices in €/kg.

		2010			2015		
		Baseline	QR-09	Change	Baseline	QR-09	Change
Liquid milk	Production	32700	33038	1,0%	32039	32450	1,3%
	Consumption	32583	32921	1,0%	31921	32332	1,3%
	Price	0,39	0,37	-5,9%	0,41	0,38	-6,8%
Butter	Production	1801	1945	8,0%	1759	1953	11,1%
	Consumption	1755	1784	1,7%	1712	1740	1,6%
	Exports	117	231	97,4%	117	284	139,3%
	Price	2,34	2,22	-5,5%	2,32	2,22	-4,5%
Skim milk powder	Production	901	1025	13,7%	812	1014	24,8%
	Consumption	742	773	4,2%	717	756	5,4%
	Exports	234	326	39,2%	169	332	96,0%
	Price	2,03	1,84	-9,3%	2,18	1,95	-10,7%
Whole milk powder	Production	904	1110	22,8%	869	1093	25,8%
	Consumption	470	479	2,0%	478	489	2,4%
	Exports	437	634	45,0%	394	607	54,0%
	Price	2,21	2,06	-6,9%	2,31	2,13	-8,0%
Cheese	Production	8704	8860	1,8%	9017	9192	1,9%
	Consumption	8261	8315	0,7%	8584	8656	0,8%
	Exports	616	718	16,5%	605	709	17,1%
Of which: Semi hard cheese	Production	2693	2812	4,4%	2799	2924	4,5%
	Consumption	2477	2503	1,0%	2606	2638	1,2%
	Exports	310	403	30,2%	287	381	32,5%
	Price	3,09	2,86	-7,5%	3,24	2,96	-8,6%
Aggregated exports	Protein equivalent	403	536	32,9%	362	524	44,9%
	Fat equivalent	340	512	50,7%	324	546	68,3%

Table 23: Percent of the additional production exported on world markets

	2010	2014
Fat	75,1%	78,7%
Protein	70,3%	70,4%

Quota removal in 2009 leads to a significant direct price decline due to the increase in production. As observed in Q1 and Q2, the negative price effect (on producer surplus) strongly dominates the positive quantity effect. From 2008 to 2009 EU27 producers loose nearly 2.7 billion euro, which in the subsequent 5 years further declines with another 1.4 billion euro, creating a producer surplus loss of 4.1 billion euro in 2014. Thereafter producers' surplus starts to increase again.

The net present value of the losses in producer surplus over the period 2009-2015 is equal to 21.1 billion euro. The equivalent annual loss associated with scenario QR-09 is 3.5 billion euro per annum (which is nearly 85 percent higher than in Q1, about 35% higher than in Q2).

Graph 18: Change in EU27 producer surplus in QR-09 as compared to baseline

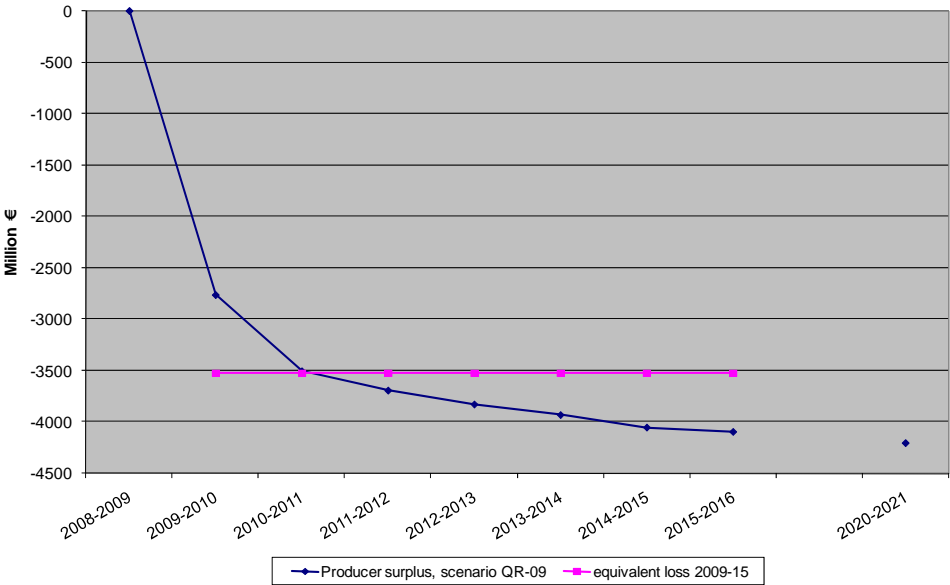

As stated for scenarios Q1 and Q2, the only change in taxpayer cost is the cost to sustain butter price through the utilization of export subsidies as well as domestic subsidies which amount to about 210 million Euros at the end of the period.

Graph 19 : Change in taxpayer cost in scenario QR-09.

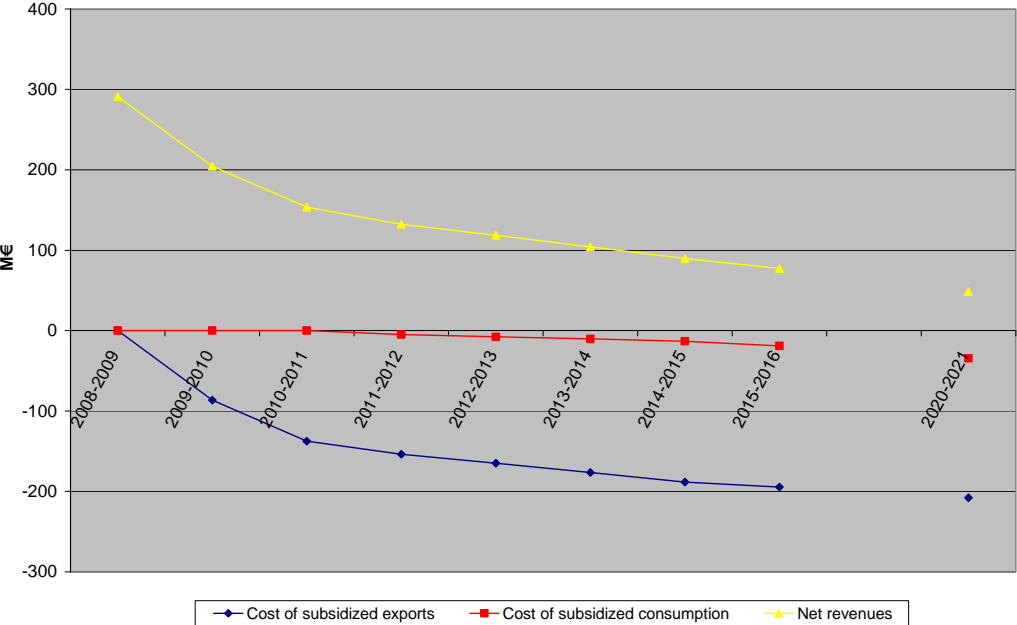

Graph 20: Change in EU25 consumer surplus in scenario QR-09.

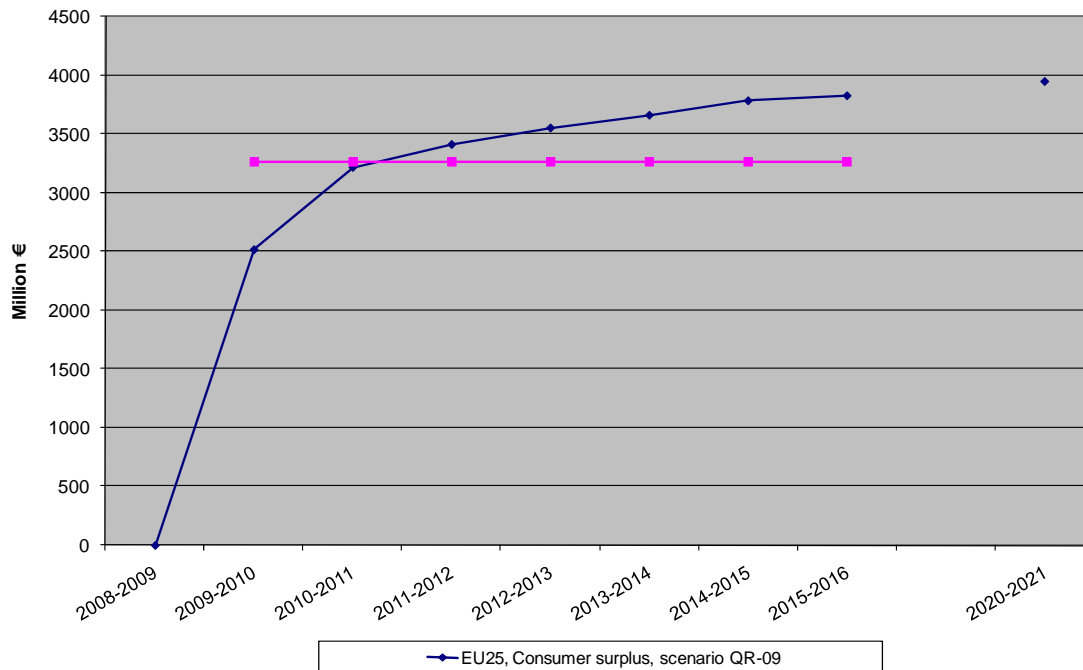

EU consumers gain from the decrease in dairy products prices. In average, over the period 2009 to 2015, the gain for EU25 consumers is about 3.3 billion € per annum. The initial increases in consumer surplus is about 2.5 billion € and reaches 3.8 billion € in 2015-16.

On the whole, as compared to Baseline, the welfare impact of the scenario is:

- A small negative change in the total welfare
- A significant transfer of surplus from producers to the benefit of consumers
- An increase in the surplus of the processing sector which originates from an increase of the processing activities.
- A small negative impact on taxpayer.

2.2.5 Scenario 4: removing quota in 2015

Removing quota causes a significant increase in milk supply as production increases by 5.5 Mt in 2015. This is because in a lot of countries, production was restricted by quotas. However, this causes a significant decrease in the raw milk price which decreases the first year after the removal by 8%. The adjustment to the new conditions will last more than one year.

After this period of adaptation, the increase in production is lower and mainly due to the increase in demand.²² This later increase in production is accompanied by a price increase. Moreover, in 2020 the supply is very similar to the one observed in the other scenarios.

Graph 21 : Change in EU27 collected production and price of milk. Scenario QR-15 compared to Baseline.

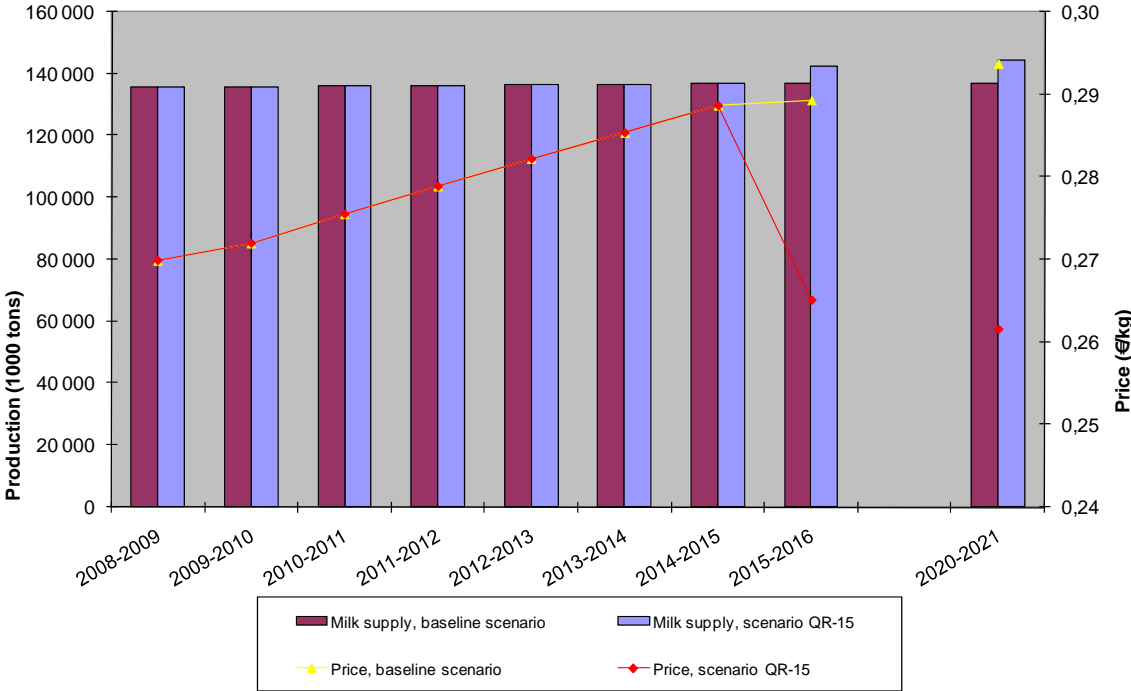

Table 24: Difference in milk production and price between scenario QR-15 and Baseline

	2010	2014	2015
Production	0,0%	0,0%	3,9%
Price	0,0%	0,0%	-8,2%

As compared to baseline, the milk price and production respectively drops by 8.2% and increases by 3.9% in 2015.

If the EU27 production is increased by 3.9% from 2014-15 to 2015-16, the increase in production is not evenly shared. In some countries, the increase of production is quite significant (Belgium, Spain, Netherlands, Ireland, Austria) while in other countries there is a decrease in the level of production due to the price effect (Portugal, Sweden, UK, Czech Republic, EU7, Bulgaria). Note that in these later

²² It should be noted that the model implicitly assumes that the new equilibrium is quickly reached - in two years in fact (producers perfectly anticipate the new prices, they are able to increase significantly and quickly their level of production, markets converge to the new equilibrium).

countries the quota rent in 2014 (that is before quota abolition) was small or equal to 0. Then the decrease in price induces a decrease in the production of these countries.

Table 25 : Change in the milk collected production in the European countries and change in quota rents. Production in 1000 tons, rents in €/kg. Scenario QR-15.

	Milk production 2014	Quota rent in 2014 (€/kg)	Milk production 2015	Variation 2015/2014
Belgium+Lux	3347	0,101	3648	9,0%
Denmark	4522	0,054	4627	2,3%
Germany	27165	0,057	28078	3,4%
Greece	760	0,056	780	2,6%
Spain	5966	0,131	6551	9,8%
France	23357	0,066	24314	4,1%
Ireland	5277	0,084	5654	7,1%
Italy	10776	0,091	11293	4,8%
Netherlands	10892	0,141	12486	14,6%
Austria	2679	0,108	2900	8,2%
Portugal	1913	0,019	1901	-0,6%
Finland	2436	0,052	2509	3,0%
Sweden	3236	0,000	3179	-1,8%
UK	13991	0,000	13753	-1,7%
Czech Republic	2735	0,015	2722	-0,5%
Hungary	1950	0,000	1964	0,7%
Poland	9122	0,014	9120	0,0%
EU7	4319	0,000	4292	-0,6%
Bulgaria	889		881	-0,9%
Romania	1251		1291	3,2%
EU27	136585	0,060	141943	3,9%

The price of butter drops when quotas are removed. However, the butter price reaches the intervention price. Then thanks to an increase in subsidies (mainly export subsidies), the domestic price of butter is sustained at the level of intervention price. This mechanism lowers the drop in butter price (and thus in farm milk price). Similarly, the SMP price drops. However, the SMP price remains larger than the intervention price and thus the drop is larger (in %).

Graph 22 : Change in butter price and per unit export subsidy. Scenario QR-15 compared to baseline.

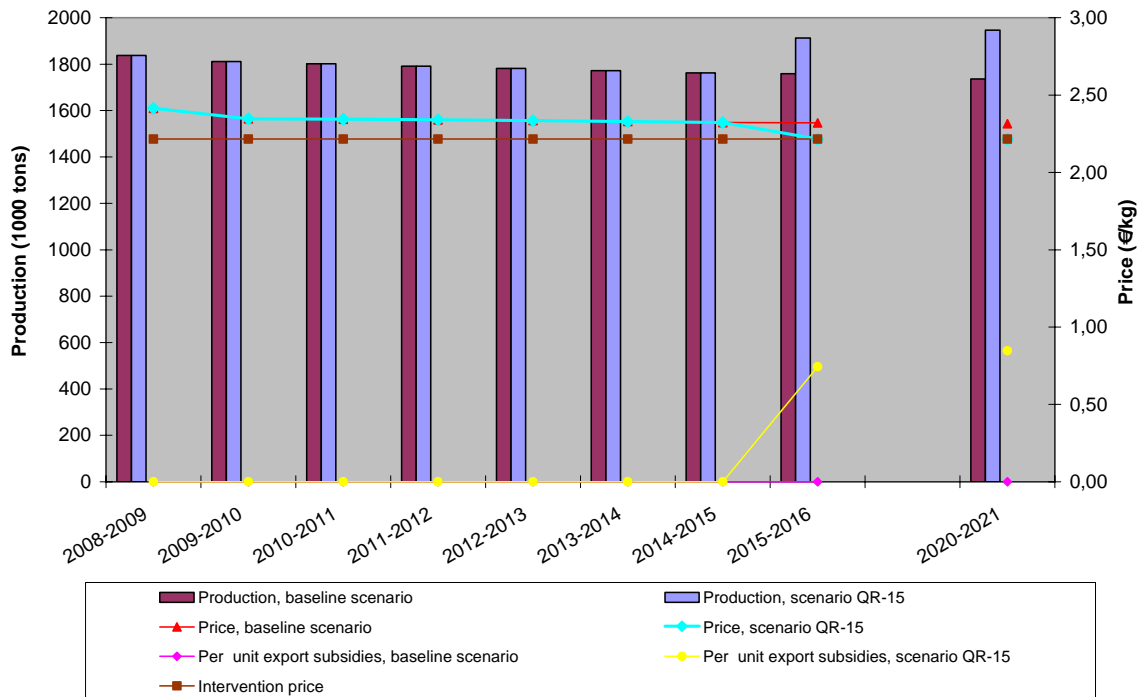

Graph 23 : Change in SMP price and production. Scenario QR-15 compared to Baseline.

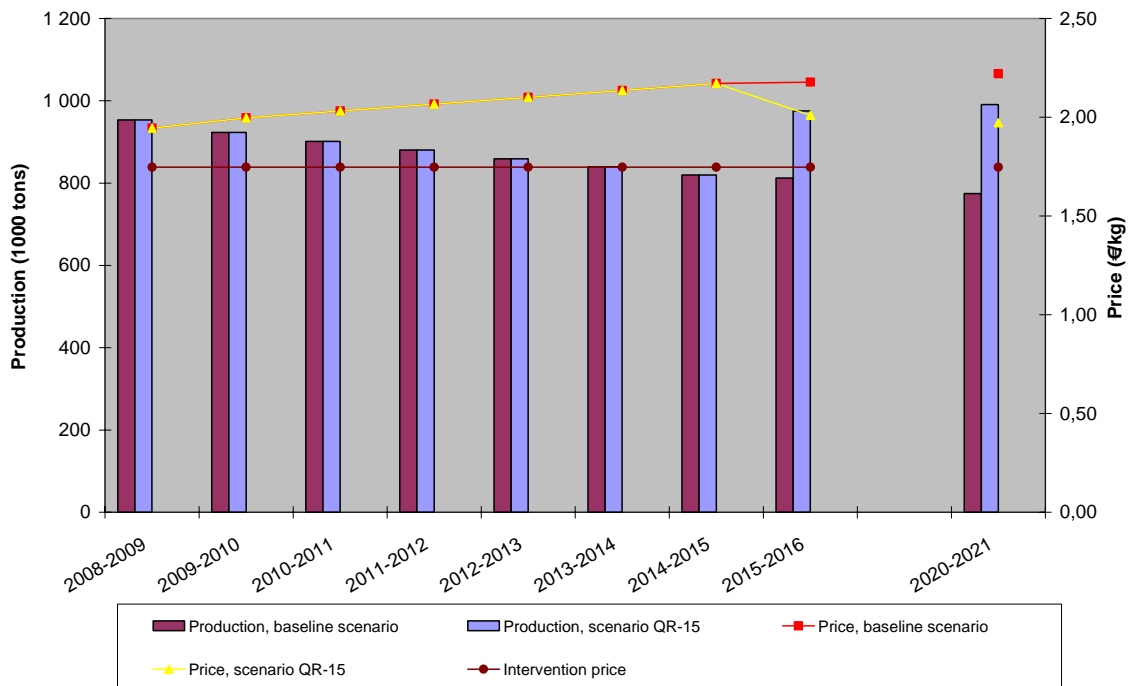

As compared to baseline, prices of dairy products are lower, by 4 to 8% in 2015. Due to lower prices, there is some additional consumption. But the increase in consumption due to the price decrease is marginal. Then, the increase in milk production is mainly exported on world markets. This is particularly true for butter thanks to the export subsidies. As for the previous scenarios about 70 to 80% of the additional production of fat and protein is exported on world markets.

Table 26 : Comparison of production, consumption, exports and prices of dairy products between Baseline and Scenario QR-15. Production, consumption and exports are in 1000 tons, prices in €/kg.

		2015		
		Baseline	QR-15	Change
Liquid milk	Production	32039	32354	1,0%
	Consumption	31921	32237	1,0%
	Price	0,41	0,38	-5,2%
Butter	Production	1759	1908	8,5%
	Consumption	1712	1737	1,4%
	Exports	117	242	106,8%
	Price	2,32	2,22	-4,5%
Skim milk powder	Production	812	973	19,8%
	Consumption	717	745	3,8%
	Exports	169	302	78,6%
	Price	2,18	2,01	-7,5%
Whole milk powder	Production	869	1039	19,5%
	Consumption	478	487	1,9%
	Exports	394	555	40,8%
	Price	2,31	2,17	-6,1%
Cheese	Production	9017	9145	1,4%
	Consumption	8584	8640	0,6%
	Exports	605	678	12,0%
Of which: Semi hard cheese	Production	2799	2888	3,2%
	Consumption	2606	2630	0,9%
	Exports	287	352	22,5%
	Price	3,24	3,03	-6,4%
Aggregated exports	Protein equivalent	362	487	34,6%
	Fat equivalent	324	489	50,8%

The decrease in farm milk price induces a drop in the producers' surplus which decreases by 3.2 billion € in 2015-16. In average over the period 2009 to 2015, this represents a loss of 386 million €. This is less than in Q1, Q2 and QR-09 as the change in the policy only starts in 2015. It should be noted that since the equivalent loss indicator only takes into account impacts over the period 2009-2015, the part of the negative impacts on producers' surplus after this period are neglected. However, even when these impacts would have been included the equivalent loss of the QR-15 scenario is expected to be below that of all other scenarios. The main reason for that is that delayed quota removal implies that the inevitable costs associated with this are moved further into the future. Due to the discounting principle, which plays a role both in the net present value and the equivalent loss calculations, the more costs are moved into the future the lower their weight in the calculation.

Graph 24 : Change in EU27 producer surplus in QR-15 as compared to baseline

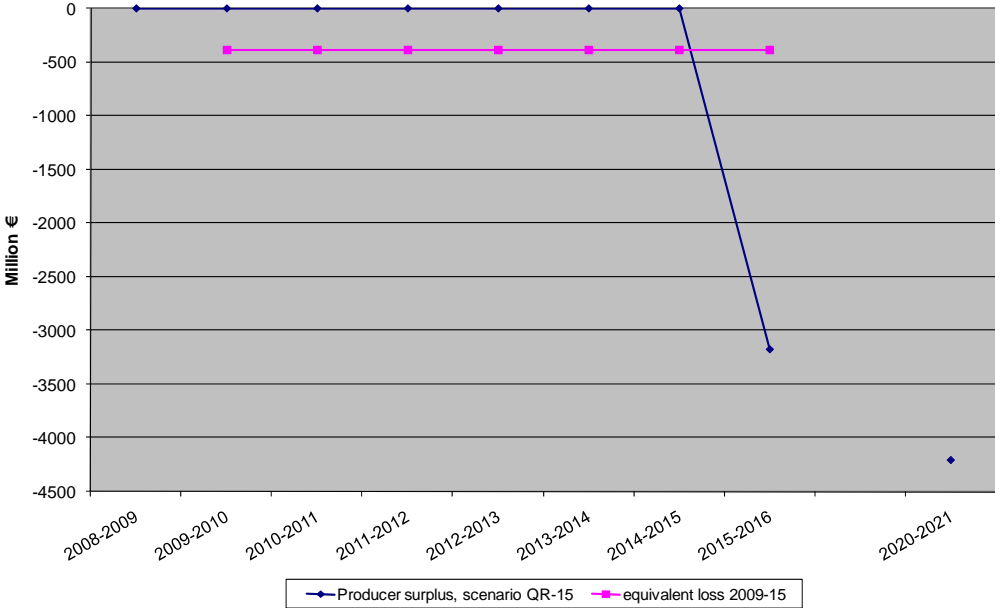

As stated for the previous scenarios, the only change in taxpayer cost is the cost to sustain butter price through the utilization of export subsidies (and some domestic subsidies) which amount to about 200 million Euros at the end of the period.

Graph 25 : Change in taxpayer revenues in scenario QR-15.

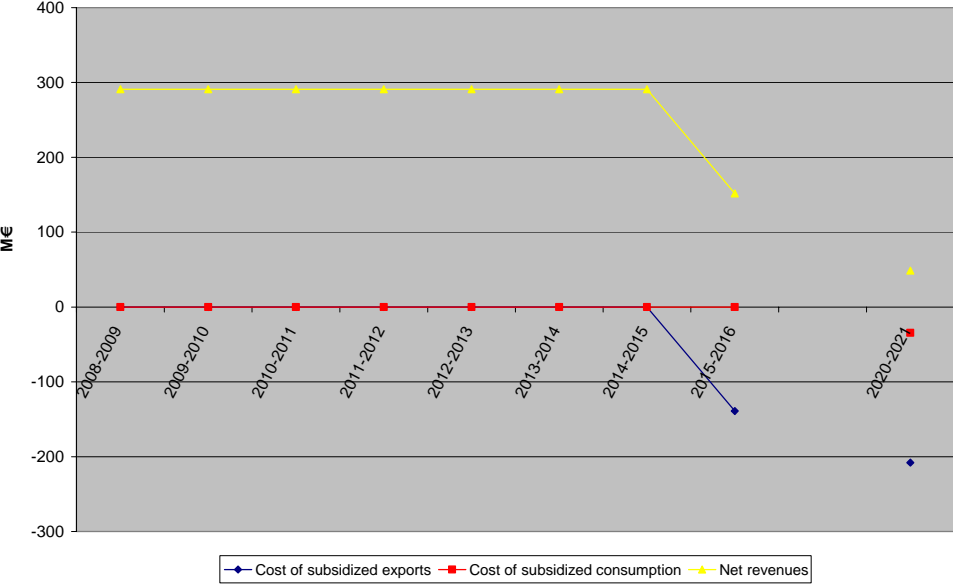

Graph 26 : Change in consumer surplus in scenario QR-15.

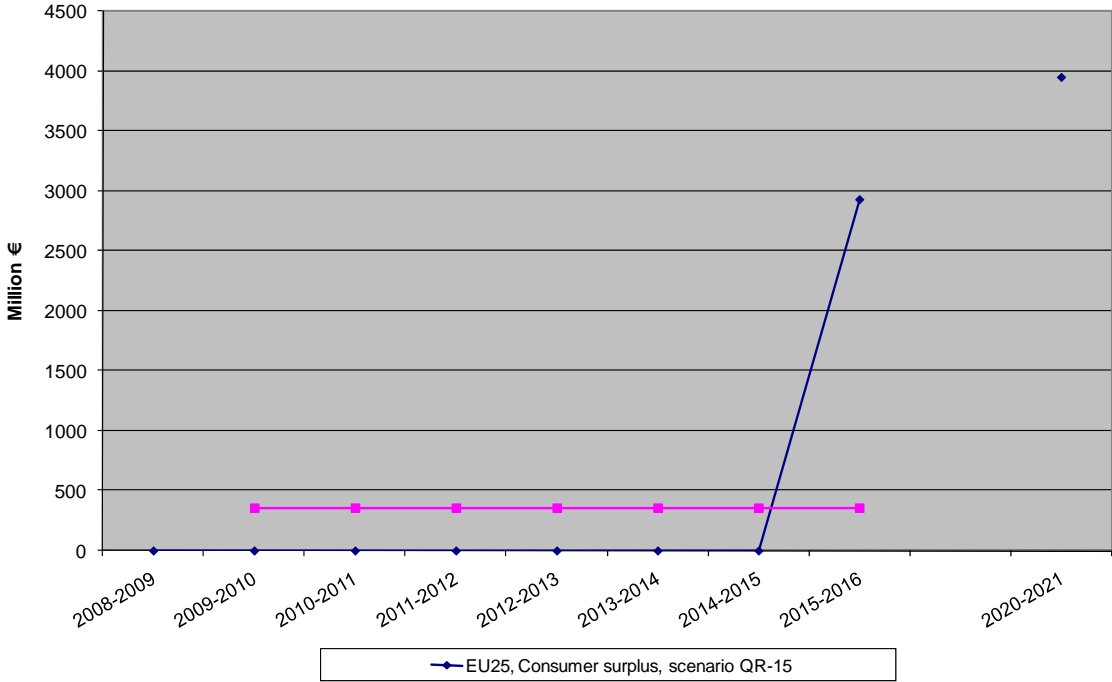

EU consumers gain from the decrease in dairy products prices. In 2015-16, the consumer surplus increases by 2.9 billion € per annum. As explained above, the average gain over the 2009 to 2015 period is small as compared to the other scenarios (it is about 0.4 billion €).

On the whole, as compared to Baseline, the welfare impact of the scenario is:

- A small and negative change in the total welfare
- A significant transfer of surplus from producers to the benefit of consumers
- An increase in the surplus of the processing sector which originates from an increase in the processing activities
- A small negative impact on taxpayer.

2.3 Comparison of scenarios.

First it is important to note that the different scenarios lead to the same situation at the end of the period of analysis (2020). There is also a strong convergence in the results in 2015 even if there are some differences due to the adjustment to quota removal in 2015 (this is particularly the case for QR-15 scenario as quotas are removed without a 'preparatory' phase).²³ Thus we will first compare the situation in 2015-16 between the baseline and one of the scenarios. This will give us the total impact of removing quotas in the EU. Then we will compare the evolution of the dairy sector for the different scenarios.

2.3.1 Situation in 2015-16 when quotas are removed

When quotas are removed, the EU milk collected production increases by 5.0% which causes a 10.3% decrease in farm milk price. This price decrease is relatively small and is limited by the existence of intervention price. Thus, if the SMP price decreases by 10.3%, the butter price decreases by only 4.5%. For SMP the intervention price does not play a role as the domestic price is larger than the intervention price. On the contrary for butter, the domestic price is equal to the intervention price and the price adjustment is modified as export subsidies (and domestic subsidies in a lower extent) are reintroduced in order to sustain the domestic butter price.

The decrease in farm milk price induces a decrease in the price of all dairy products. Their consumption thus increases. However the increase in consumption remains small as the price change varies from 4% to 10% depending on the products and the demand is rather price inelastic. The increase in production of dairy products thus induces a significant increase in the EU exports. The exports of industrial products increase very significantly (+54% for WMP, +90% for SMP). The exports of cheese also increase even if the percent is lower (+16%). The increase in the EU exports induces a decrease of world price by 7% to 8% (except for butter where it declines by more than 10%). On the whole, 80% of the additional production of fat is exported on world markets and 70% of the additional production of protein is exported.

Producers' surplus decreases by 4 billion € as the price effect is larger than the quantity effect. Consumers benefit from the decrease in price (at EU -25 level this amounts to about 3.7 billion €) while taxpayer cost is increased by the cost of sustaining the butter price. The processor surplus also increases and the net welfare effect is small

²³ The convergence in the results is explained by the instantaneous adjustments of dairy product markets in the model as well as a fast adjustment of milk production (2 years) to the new situation created by quota removal.

Table 27 : Milk and dairy products market equilibrium. Comparison of Baseline and a quota removal scenario. Year 2015-16. Quantities in 1000t, prices in €/kg, surplus in M€.

	Baseline	Quota removal	Difference
Cow raw milk			
Price	0.289	0.260	-10.3%
Quota rent	0.061	0.000	-100.0%
Total production	139 893	146 841	5.0%
Collected production	136 663	143 610	5.1%
Number dairy cows	20 776	21 504	3.5%
Butter			
Price	2.320	2.216	-4.5%
Production	1 759	1 943	10.5%
Consumption	1 712	1 738	1.5%
EU imports	5	5	0.0%
EU exports	117	284	142.7%
World price	1.518	1.279	-15.8%
Skimmed Milk Powder			
Price	2.178	1.955	-10.3%
Production	812	1 003	23.4%
Consumption	717	755	5.2%
EU imports	74	74	0.0%
EU exports	169	322	90.3%
World price	2.143	1.997	-6.8%
Whole Milk Powder			
Price	2.314	2.136	-7.7%
Production	862	1 084	25.7%
Consumption	471	482	2.3%
EU imports	3	3	0.0%
EU exports	394	605	53.6%
World price	2.144	1.968	-8.2%
Cheese			
Production	9 017	9 180	1.8%
Consumption	8 584	8 654	0.8%
EU imports	173	173	0.0%
EU exports	605	699	15.5%
Semi Hard Cheese			
Price	3.237	2.970	-8.3%
Production	2 799	2 914	4.1%
Consumption	2 606	2 637	1.2%
EU imports	94	94	0.0%
EU exports	287	371	29.2%
World price	2.478	2.293	-7.5%
Fresh products			
Price	0.886	0.855	-3.5%
Production	10 670	10 733	0.6%
Consumption	10 568	10 632	0.6%
Fluid Milk			
Price	0.406	0.379	-6.6%
Production	32 039	32 437	1.2%
Consumption	31 921	32 320	1.2%

2.3.2 Comparison of the four scenarios from 2009 to 2015

From the four scenarios analyzed it is in scenario Q2 that the increase in production is the smoothest. It regularly increases and removing quota at the end of the period does not provoke a sharp increase in the production. In scenario Q1, the increase in production when removing the quota is larger than during the previous years. Obviously the two other scenarios lead to different patterns of increase.

Graph 27 : Change in EU27 milk collected production. Comparison between all scenarios.

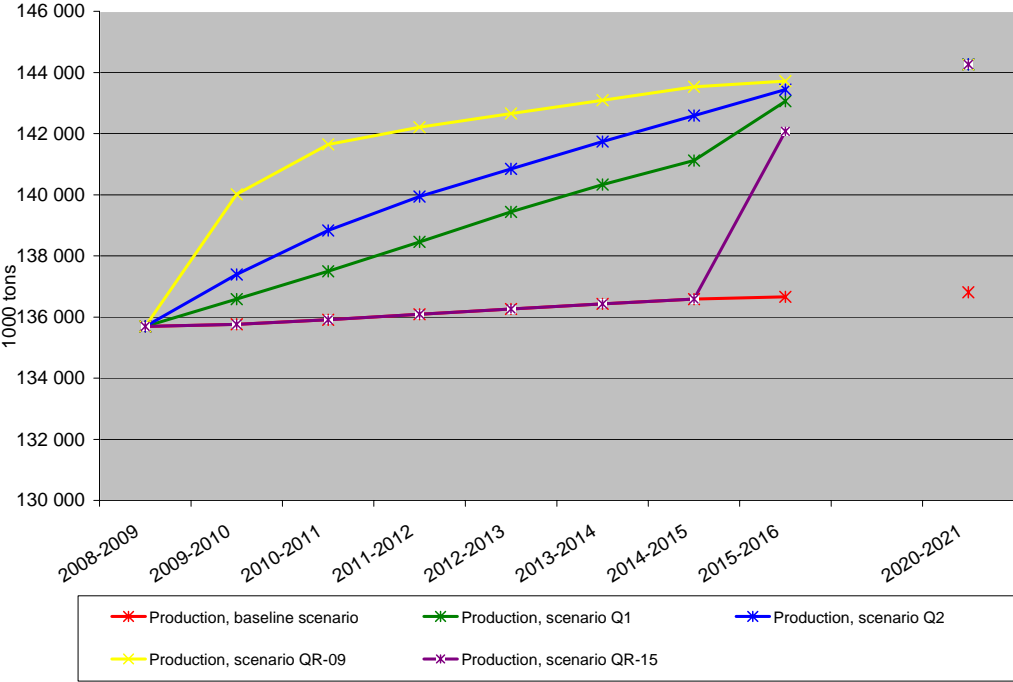

We present on the following graphs the level of collected production as well as the available delivery quotas of each country in 2014-15 for three scenarios: baseline, Q1 and Q2. For baseline, almost all countries have a binding quota. The exceptions are Sweden, UK, Hungary as well as EU7. In these countries production in Q1 and Q2 are lower. This is due to the price effect. As the EU production increases (in Q1 and Q2 as compared to Baseline), the milk price is lower which generates in these countries a decrease in the milk production. In Portugal, Czech Republic, Bulgaria, and Poland the production in Q1 and Q2 are almost identical to the production in Baseline. In the other countries, the production in scenarios Q1 and Q2 is larger than in Baseline.

Graph 28: Delivery quotas and collected production in the small EU milk producer countries in 2014-15

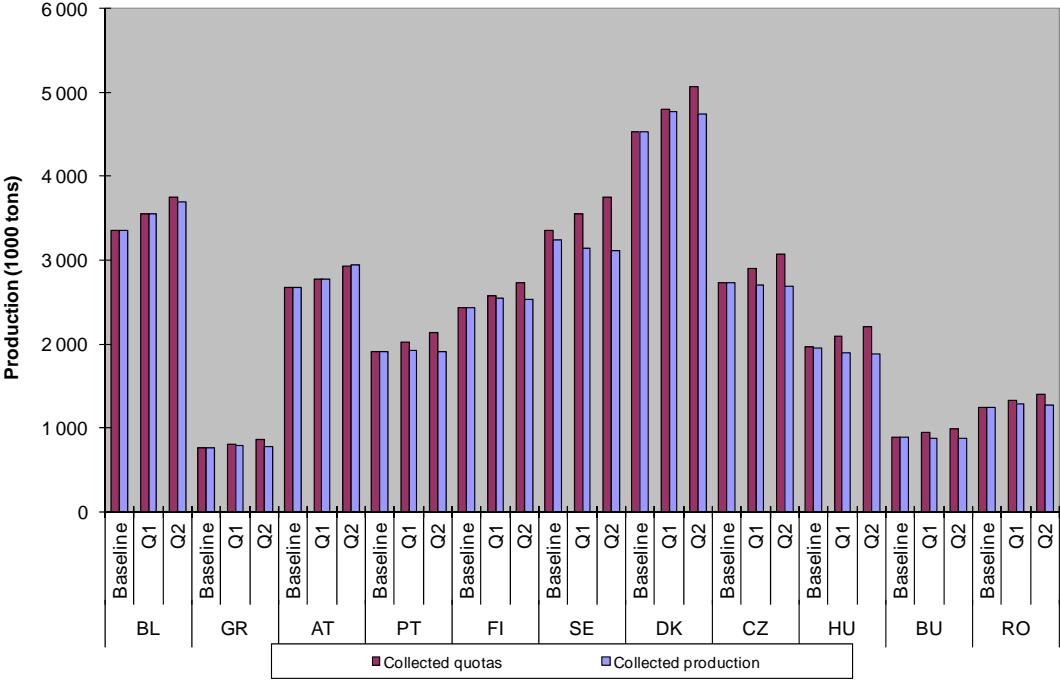

Graph 29 : Delivery quotas and collected production in the large EU milk producer countries in 2014-15

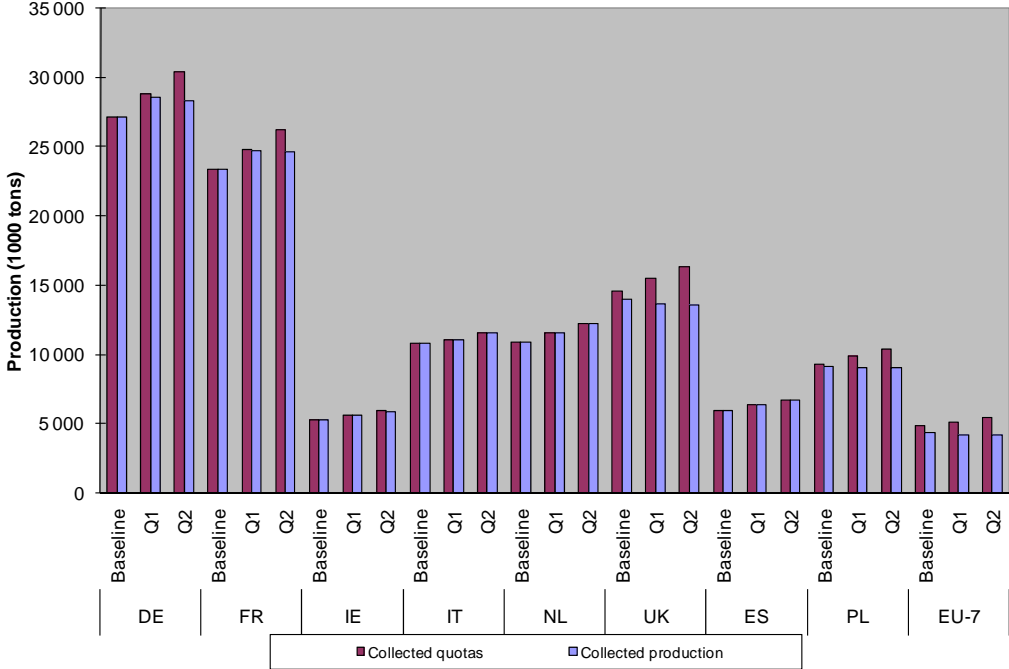

In terms of price evolution, Q1 and Q2 scenarios have the smoothest price evolution. The variation from one year to another is small. Producers benefit from higher prices in Q1 than Q2 as production is lower but the difference remains small.

Graph 30 : Change in EU27 milk price. Comparison between all scenarios.

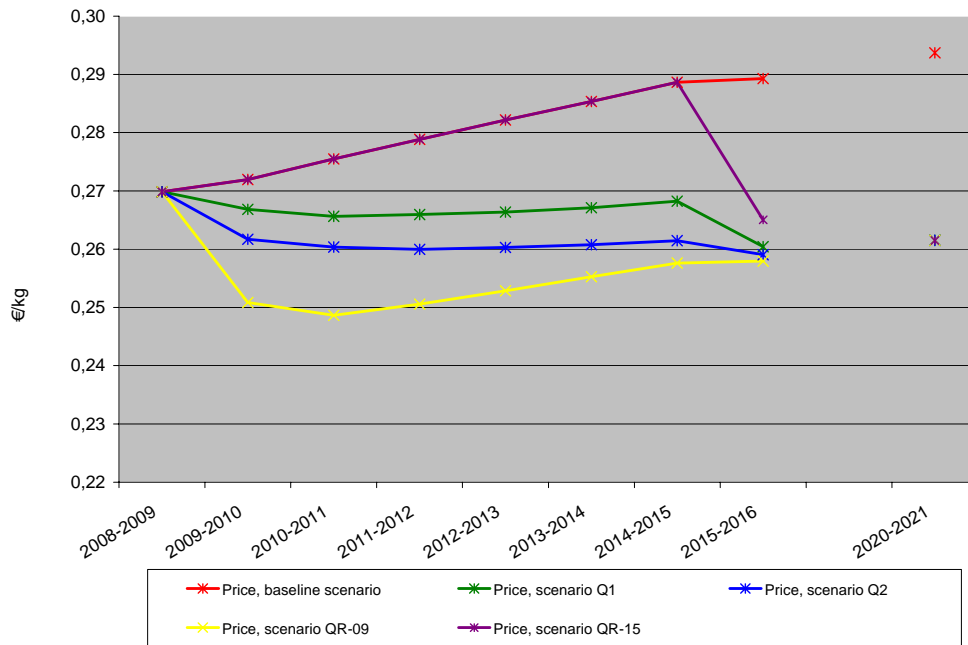

As explained in the previous section, with the increase in milk production, the domestic butter price quickly reaches the intervention price. This is possible thanks to the use of exports subsidies. Then, the scenarios only differ on the date when the butter price is equal to the intervention price.

Graph 31 : Change in EU27 butter price. Comparison between all scenarios.

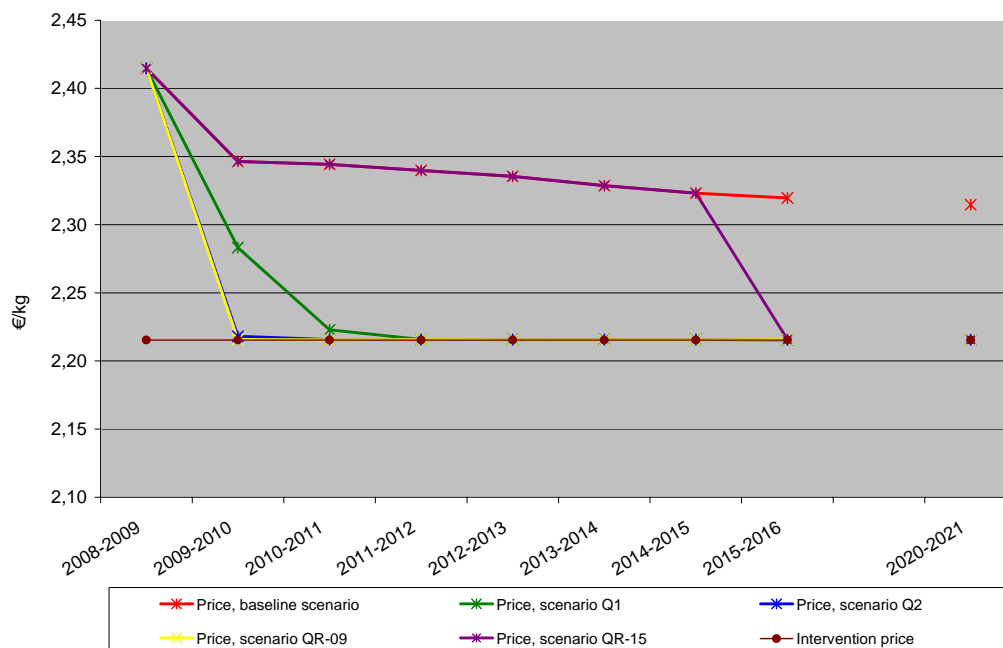

To maintain the domestic price of butter at the intervention price, the use of export subsidies is required. For a given year the larger the level of production (of milk) the larger the per-unit export subsidy.

Graph 32 : Change in the per unit butter export subsidies. Comparison between all scenarios.

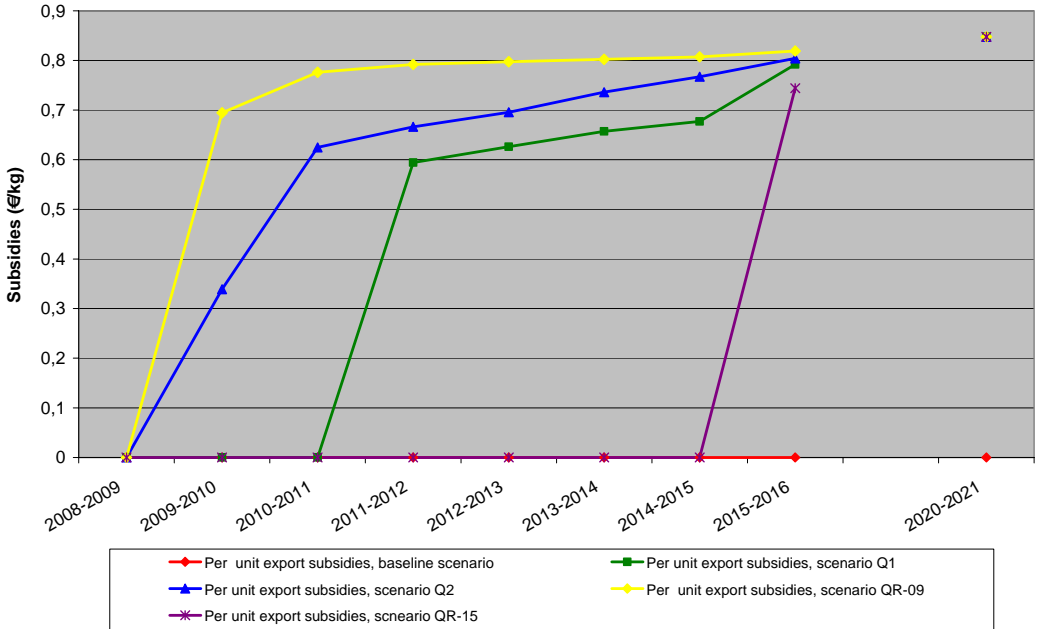

In the baseline the production of butter regularly decreases in response to the decrease in the domestic demand for butter and the increase in the fat demand for cheese production. On the contrary, this tendency is reversed in the four scenarios. The butter production increases mainly to satisfy exports (thanks to the use of export subsidies). As for milk production, the increase in production is evenly distributed over time in scenario Q2.

Graph 33 : Change in EU27 butter production. Comparison between all scenarios.

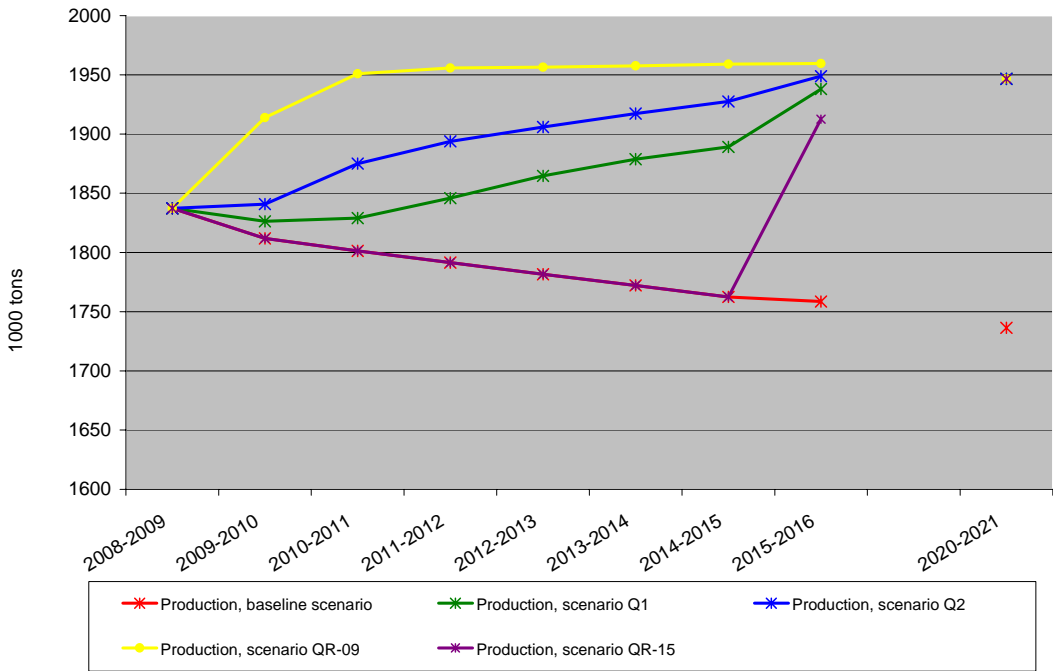

The increase in butter production is mainly exported on world markets thanks to the use of export subsidies.

Graph 34 : Change in EU27 butter exports. Comparison between all scenarios.

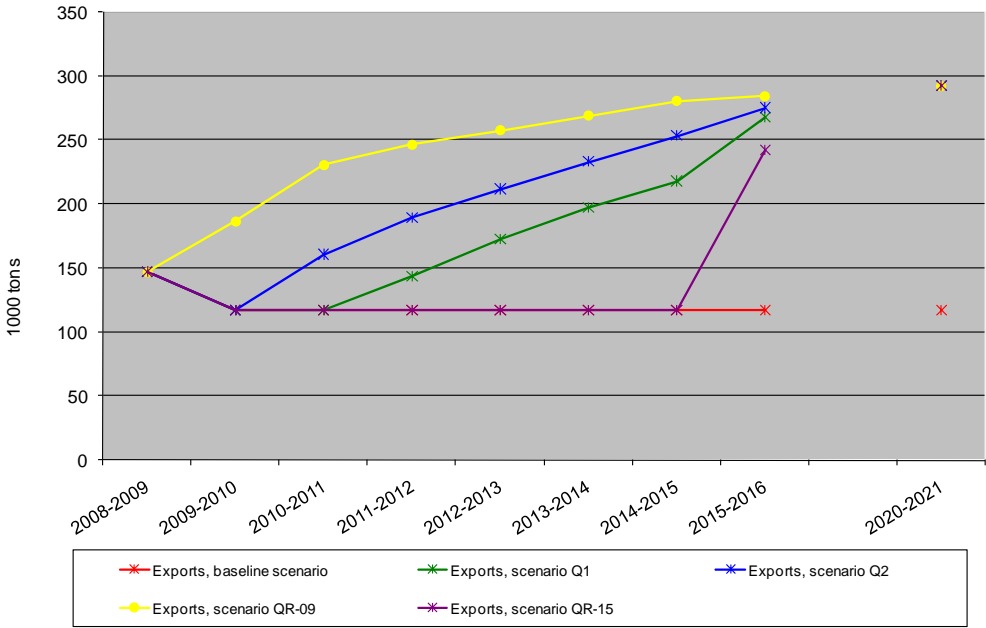

Contrary to the butter case, the price of SMP does differ among the different scenarios. SMP price is always larger than the intervention price (thus export subsidies are never used). Then the difference in protein supply (due to difference in milk production) has a direct impact on SMP price. The larger the milk production is, the lower the SMP price. The smoother evolution of SMP price is for scenarios Q1 and Q2 which are the soft landing scenarios.

Graph 35 : Change in the EU27 SMP price. Comparison between all scenarios.

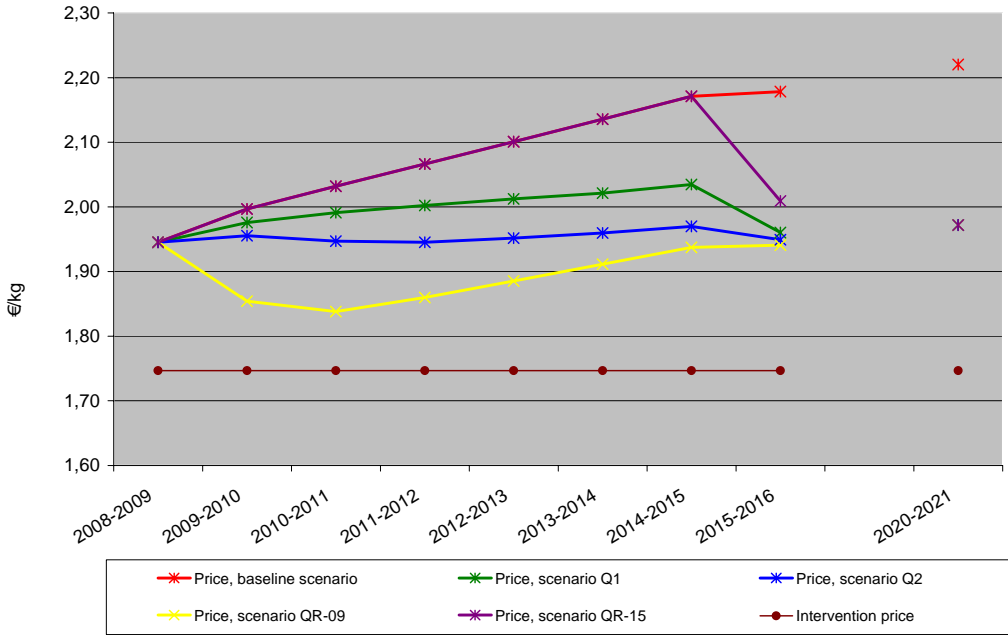

While in baseline the SMP production significantly declines over time (competition with cheese and other dairy products for protein), the production of SMP is roughly stable in scenarios Q1 and Q2. The change in SMP production is mainly explained by the evolution of SMP exports.

Graph 36 : Change in the EU27 SMP production. Comparison between all scenarios.

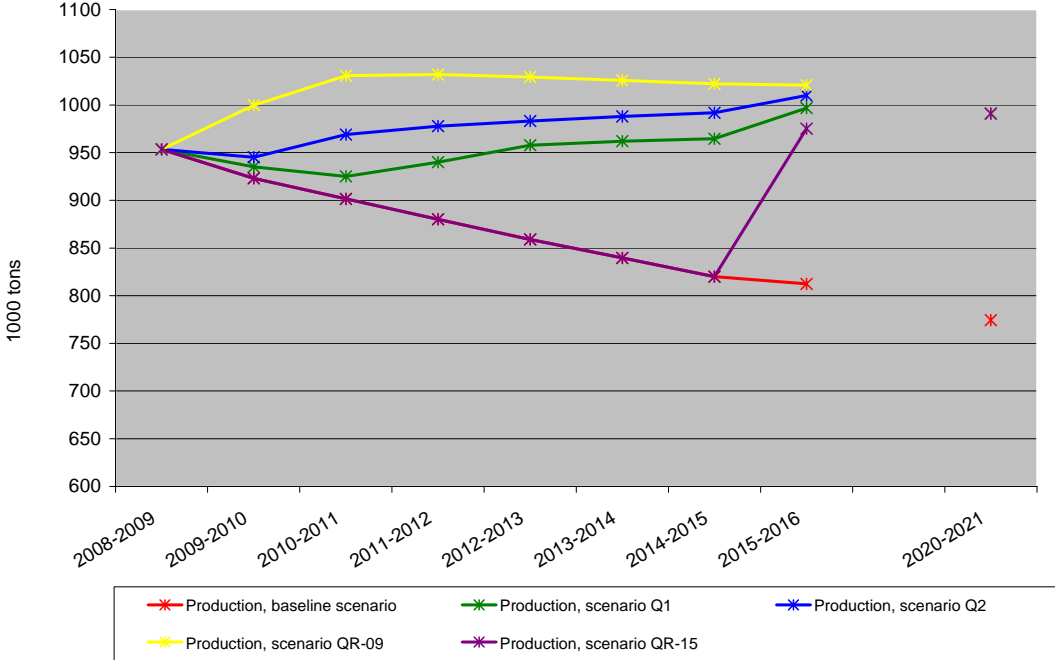

Graph 37 : Change in the EU27 SMP exports. Comparison between all scenarios.

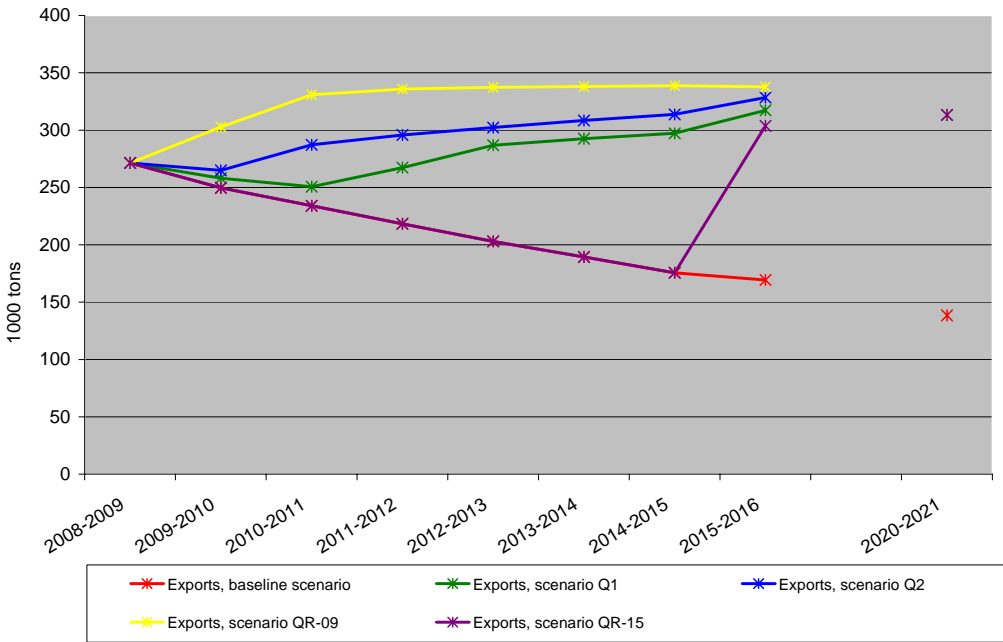

As for butter and SMP, the production of WMP is also significantly affected by the increase in milk production. The negative trend in the production observed in baseline is more than offset by the increase in milk production under the different scenarios.

Graph 38 : Change in EU27 WMP production. Comparison between all scenarios

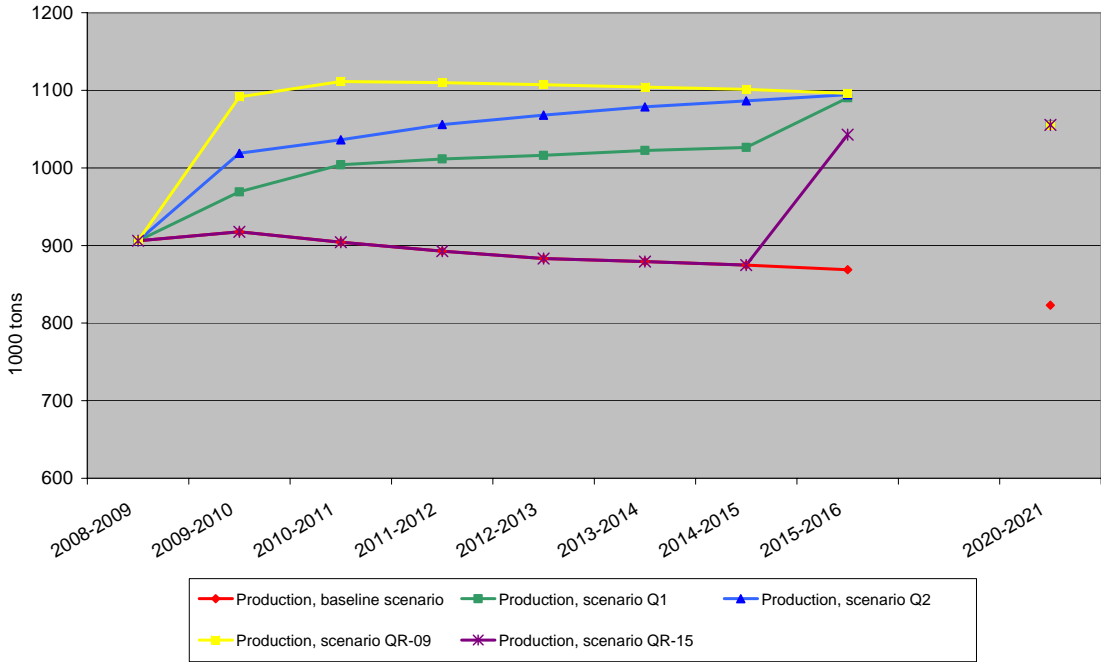

Thus, the production of industrial products is significantly affected by the increase in quota and the quota removal. While they experience a decrease in production in Baseline, this trend is reversed when quota are gradually increased or removed. It is for soft landing scenarios that the evolution of production is the more evenly distributed over time.

Contrary to industrial products, the production of final consumption products is less affected. As shown by the example of cheese production, in all scenarios (including baseline), their production increase. This is mainly in response to the increase in demand for these products. Then in the different scenarios analyzed, this trend is reinforced.

Graph 39 : Change in EU27 semi hard cheese production. Comparison between all scenarios.

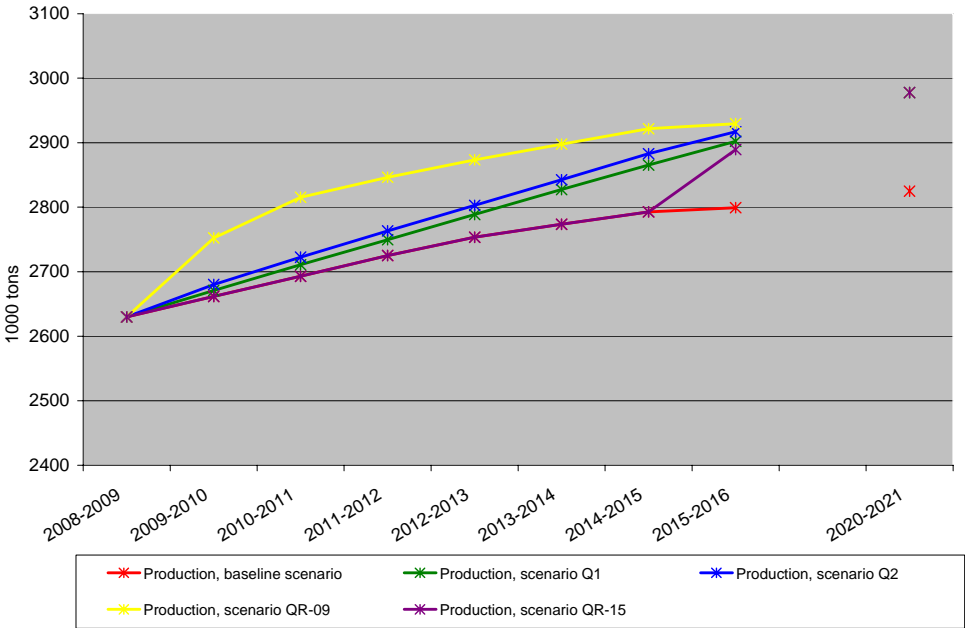

Graph 40 : Change in EU27 cheese production. Comparison between all scenarios

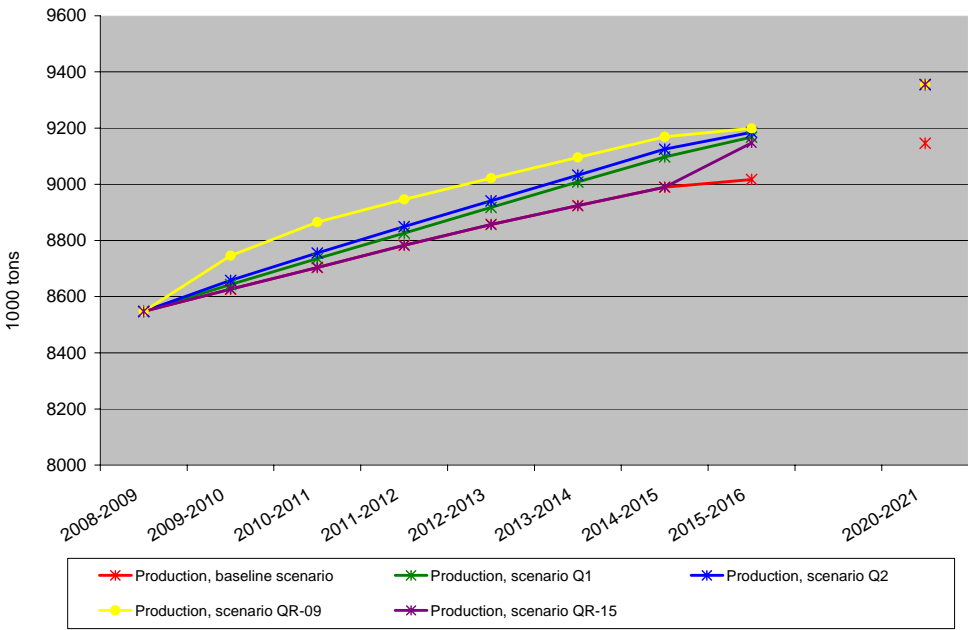

Part of the differences in production of cheese is explained by a difference in the exports. The other part is the consequence of the price effect (consumption increase when prices are lower).

Graph 41 : Change in the EU27 cheese exports. Comparison between all scenarios.

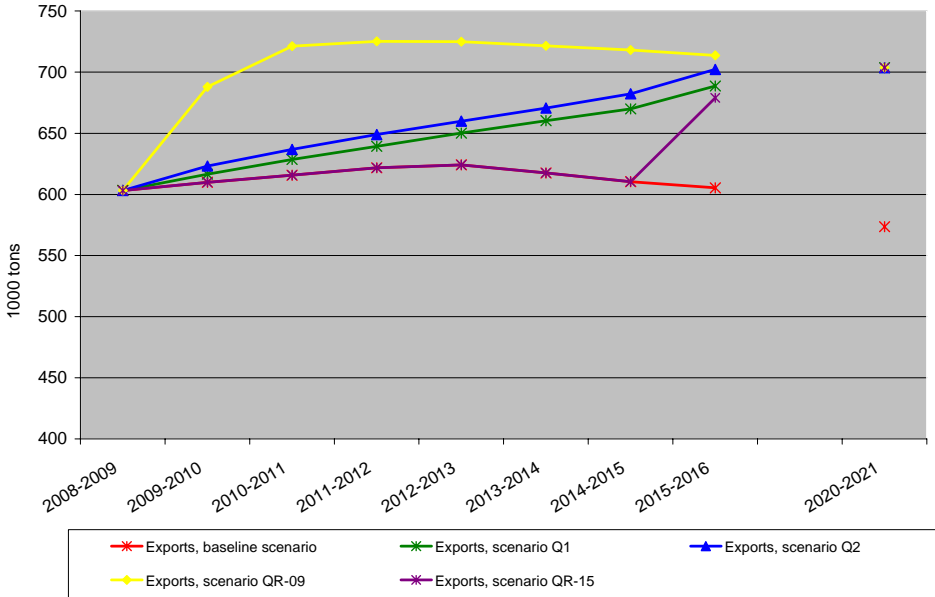

The changes in milk production have implication on the dairy cow stock, on feed use by the dairy sector as well as on beef production. We report in the three following graphs quantitative information about these three elements. The dairy cow stock is declining over time (higher yielding cows have a lower feed conversion factor) and largely follows the trend in milk production. QR-09, the scenario which gives the largest expansion of production has the highest dairy cow stock. After the removal of

the quota the dairy cow stock increases. In 2010-11, the dairy cow stock in this scenario is about 500 thousand more dairy cows than the standard scenario (for a total stock larger than 20 Million cows).

Graph 42: Change in the EU dairy cow stock

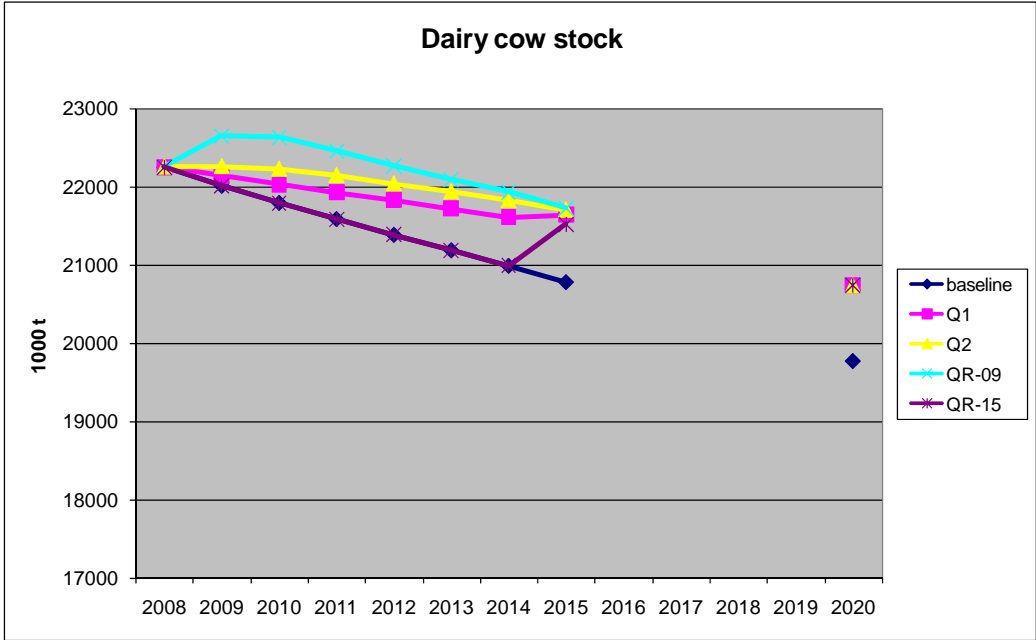

The use of (purchased) feed input follows the dairy cow stock, and thus shows a similar pattern than the dairy cow stock.

Graph 43: Change in the EU feed inputs

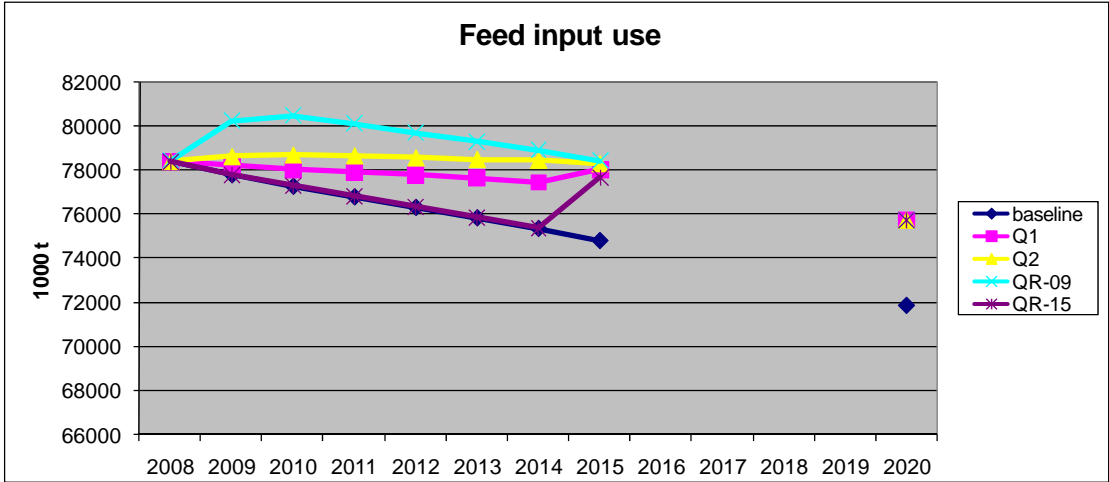

The production of beef associated with the standard scenario is largely linked to the dairy cow stock. It also shows a declining trend. With respect to beef there is another mechanism, notably the substitution of dairy cows for suckler cows, which is likely to have an impact on the total supply of beef. In the current version of the model this suckler cow-substitution effect could not be properly taken into account. This implies that the decline in beef production as currently projected is likely to be overestimated. We expect a real decline of beef production, i.e. the dairy sector impact to be dominating, but a less substantial one. Then the impacts of the scenarios are similar to the one

described for the dairy cow stock. The trend in a decreasing beef production is lower but still exists in these simulations (which certainly over-estimate this tendency).

Graph 44: Change in the EU beef production

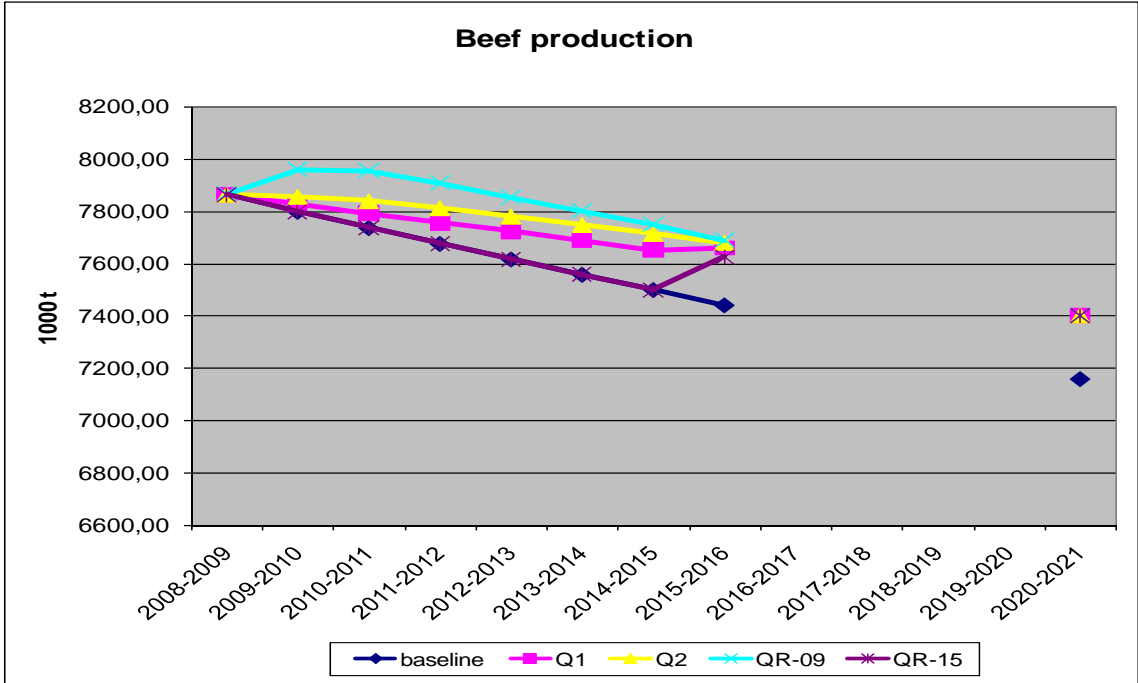

The differences in price evolution and production evolution obviously impact the producers’ revenues and incomes. As stated before, the (positive) quantity effect due to the increase of production quota or their removal never compensate for the negative price effect. Thus, the larger the level of production a given year is, the lower the price and the producers’ surplus. Over the 2009-10 to 2015-16 period, the equivalent annual loss in producers’ surplus ranges from 386 million euro per annum for scenario QR-15 to 3 524 million euro per annum for scenario QR-09. Producers losses in scenario Q1 and Q2 are intermediate and amount to respectively 1 911 and 2 586 million euro per annum. The decrease in producers’ surplus integrates the decrease in quota rents as well as price effects. Because quota, which corresponds to a ‘right to produce’, is an asset, the decrease in quota rent will affect the value of this asset. This means that part of the loss of surplus will be borne by owners of quota who are not always the producers. The relative share of loss that is borne by dairy producers rather than owners is variable among countries. It depends, among other elements, how the market for quota is organized, if any

Graph 45: Change in EU27 producers' surplus.

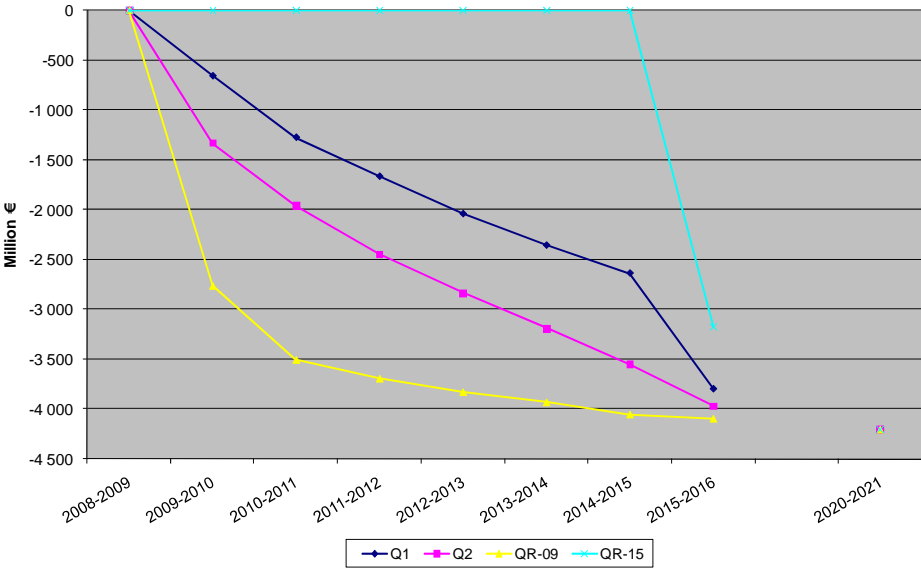

The difference in taxpayer revenues are linked to the cost of export subsidies and in a lower extent to the cost of domestic subsidies. The cost of export subsidies reaches 195 million Euro in 2015 (scenario QR-09) while the revenues from import is about 290 million Euro. It should be acknowledge that the cost of export subsidies is strongly linked to the evolution of world markets in the future and thus highly depends on the assumption we have made with respect to the evolution of demand in the RoW. On the whole, given our assumptions the taxpayer benefits decrease from 290 million Euro to about 100 million Euros.

Graph 46 : Change in EU27 taxpayer revenues in all scenarios.

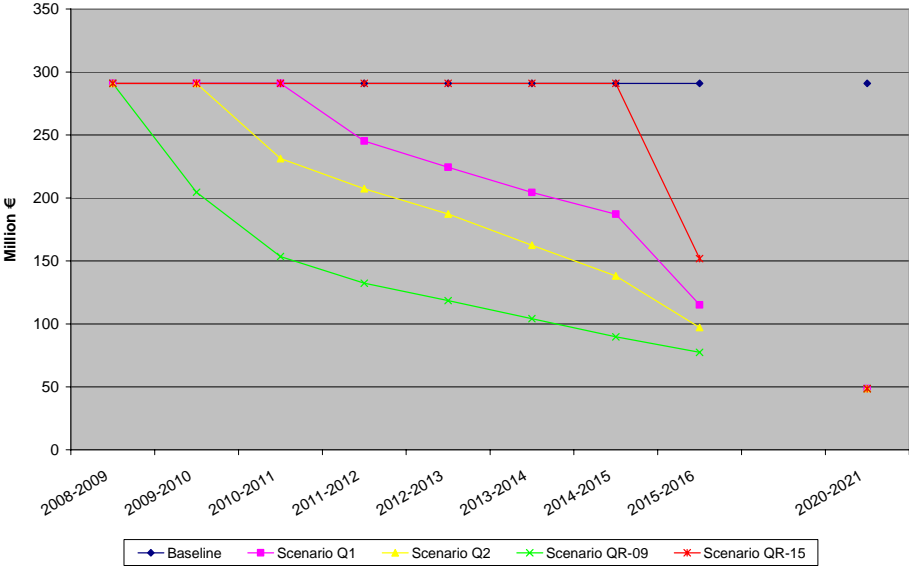

Graph 47 : Change in EU25 consumer surplus in all scenarios

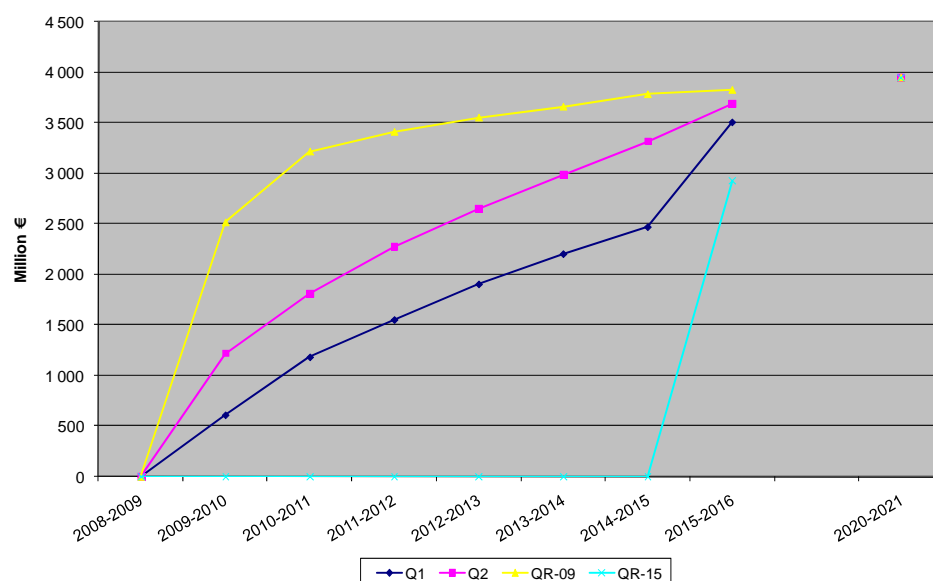

The differences in price evolution obviously impact the consumers' surplus. From the consumer point of view, the larger the price decreases the better. Over the 2009-10 to 2015-16 period, the equivalent annual gain in consumers' surplus (EU25) ranges from 348 million euro per annum for scenario QR-15 to 3 186 million euro per annum for scenario QR-09. Consumers gains in scenario Q1 and Q2 are intermediate and amount to respectively 1 769 and 2 366 million euro per annum.

Table 28: Welfare impact of the scenarios. Change (as compared to Baseline) in the net present value of surpluses over the 2008-2015 period in the EU25. Billion €

	Q1	Q2	QR-09	QR-15
Producers	-11,46	-15,43	-21,14	-2,30
Consumers	10,62	14,20	19,13	2,09
Taxpayers	-0,36	-0,55	-0,88	-0,10
Welfare	-0,53	-0,88	-1,66	-0,17

This is the net present value of the gains and losses computed with an interest rate of 4% (real term).

Table 29: Welfare impact of the scenarios. Change (as compared to Baseline) in the annual equivalent value of surpluses in the EU25. Million €

	Q1	Q2	QR-09	QR-15
Producers	-1909	-2571	-3521	-383
Consumers	1769	2366	3186	348
Taxpayers	-60	-91	-146	-16
Welfare	-88	-147	-276	-28

This is the equivalent annual value of the NPV displayed in Table 29.

On the whole, as compared to Baseline, the welfare impact of the different scenarios is:

- A small negative change in the total welfare
- A significant transfer of surplus from producers to the benefit of consumers

- An increase in the surplus of the processing sector which originates from the increase in processing activities.²⁴
- A small negative impact on taxpayer.

2.4 Sensitivity Analysis

In order to test how results vary with some parameters of the model, we conducted a sensitivity analysis. Four variants were designed:

- The 'no subsidy' case. In this variant, whatever the price of butter and SMP, we assume that the EU will not use any subsidies (neither domestic nor export subsidies) to sustain the domestic prices.
- The 'low demand' case. In this variant, we assume that the evolution of demand is lower than in the standard case. We have halved the trends in EU15 domestic consumption, decreased by 30% the trends in EU10 domestic consumption and considered lower change in the demand in the RoW.
- The 'low cost' case. In this variant, the marginal costs of production are estimated based on the average milk variable costs reported in the DG AGRI internal analysis of milk margins in the EU (2004).
- The 'WTO' case. In this variant, export subsidies are phased out over a 6 year period starting in 2009. Import tariffs are gradually decreased over the same period. For each product, the amount depends on the initial level of tariffs.

We now discuss how results of Q1 scenarios vary according to these four variants. We will then briefly present results for the other scenarios (as the impacts are very similar for all scenarios).

2.4.1 Analysis of sensitivity: Scenario Q1

To begin let us define the qualitative impact of each variant:

- The 'no subsidy' case. Compared to the standard case, this scenario thus corresponds to a potential shift in the demand addressed to the EU dairy sector. When subsidies are not used in the standard case, there is no difference. On the contrary when subsidies are used in the standard case, this variant corresponds to a downward shift in the demand. Thus, we anticipate that both price and production of milk will be either equal (when subsidies are not used in the standard case) or lower than in the standard case.
- The 'low demand' case. Compared to the standard case, this variant corresponds to a downward shift in the demand. Thus, we anticipate that both price and production of milk will be lower than in the standard case.

²⁴ The increase in processors surplus is not quantified as it comes from changes in marginal costs of processing as well as changes in the margins that could exist on differentiated products. The level of these margins is not known precisely which explain the absence of quantification of the surplus.

- The 'low cost' case. Compared to the standard case, this variant corresponds to a downward shift of the supply. Thus, we anticipate that the level of milk production will be larger than in the standard case. Conversely, we anticipate that the level of milk price will be lower than in the standard case.
- The 'WTO' case. Compared to the standard case, this scenario is mixed. The decrease in import tariffs in the RoW corresponds to an upward shift in the demand addressed to the EU dairy sector, the decrease in EU export subsidies corresponds to a (potential) downward shift in the demand and finally the decrease in the EU import tariffs is similar to a downward shift in the dairy products supply in the EU. The final impact will depend on the importance of these three elements. In practice, the impact of lowering the import tariffs in the EU will be small as the decrease is rather small (butter and cheese were considered as sensible products meaning that the decrease in the import tariffs are small for these products). Then, when export subsidies are not used in the standard case, we anticipate that both the level of production and price of milk will be larger than in the standard case. Conversely, when export subsidies are used in the standard case, the two effects play in opposite direction. The result thus depends on the magnitude of the two effects. We can get an increase in both production and price (of milk) or both a decrease in price and production of milk.

In the following, we provide a table and some graphs to present the quantitative impact of the sensitivity analysis for scenario Q1. The explanations given in the previous paragraphs provide the mechanisms that explained these quantitative results.

Table 30: Variation of production and price of milk in the four variants as compared to the standard case. Scenario Q1. Year 2015-16

	Variation in % as compared to Q1 in the standard case		Index of production and price Relative to Baseline in 2015-16 (baseline Index =100)	
	Production	Price	Production	Price
No Subsidy	-0.6%	-1.7%	104,0	88,7
Low Demand	-1.0%	-2.8%	103,6	87,7
Low Cost	3.5%	-6.5%	108,3	84,3
WTO	-0.4%	-1.3%	104,2	89,0

The larger impact is for 'Low Cost' variant while a lower impact is found for 'Low Demand'. It is not a general result but rather to be related to the variation of the parameters between the standard case and the two variants.

The impact of 'WTO' variant is relatively small. This is because the positive effect due to a decrease in import tariffs in the RoW partly compensates for the negative effect due to the removal of export subsidies. It is worth mentioning that in 2015-16, in the standard assumption case only fat products were exported with export subsidies.

Box 5: Some quantitative information on the variants

Low marginal costs assumptions. €/kg.

Country	BL	DK	DE	GR	ES	FR
Low Marginal Cost	0.140	0.208	0.187	0.224	0.157	0.185
Country	IE	IT	NL	AT	PT	FI
Low Marginal Cost	0.142	0.194	0.167	0.175	0.172	0.262
Country	SE	UK	CZ	HU	PL	AC7
Low Marginal Cost	0.232	0.172	0.232	0.266	0.132	0.181

Assumptions for the WTO variant

- 1) EU exports subsidies:
 - a. Value: phasing out. 6 steps. Start in 2009. 0 subsidy in 2014.
 - b. Volume: decrease in 2009 by 31% for butter, 44% for SMP, 23% for cheese, 24% for other products. Then stable. Then 0 in 2014.
- 2) EU import taxes and quotas
 - a. Gradual cut (over 6 years) in over quota and in quota tariffs according the initial rate of taxation (AVE) and the following rule :
 - i. <20% 50% reduction
 - ii. 20% to 50% 57.5% reduction
 - iii. 50 to 75% 63.5% reduction
 - iv. >75% 69.5% reduction
 - b. In practice for the EU it means that in quota and over quota tariffs are reduced by
 - i. Butter: both in and out of quota rates reduced by 23%
 - ii. Powders: both in and out of quota rates reduced by 63.5%
 - iii. Cheese: both in and out of quota rates reduced by 21.4%
 - c. Import quota almost doubled (over 6 years) for butter and cheese.
- 3) RoW Import taxes;
 - a. Gradual cut in over quota tariffs (over 6 years)
 - b. America:
 - i. Butter: 23% reduction
 - ii. Powders: 63.5%
 - iii. Cheese: 21.4%
 - c. Other areas (Africa, Asia, CEI): 2/3 of developed country cuts and thresholds
 - i. 50% or less for all products.

As shown on the two following graphs, the quantitative impacts of the variants vary over time. In particular, the impact of 'WTO' variant does change in 2014-15. From 2009-10 to 2013-14, the impact on price and production is positive as the export subsidies are not different between standard case and the variant (remind that it is a gradual removing of export subsidies). On the contrary, when export subsidies are completely removed, the negative impact of EU milk production and price annihilates the positive impact due to lower tariffs in the RoW.

The impact of 'Low Cost' is maximum when quotas are removed. Before that date, the quota limits the possibility to expand production in a lot of countries.

Graph 48 : Scenario Q1. Analysis of sensitivity. Change in the EU27 milk collected production.

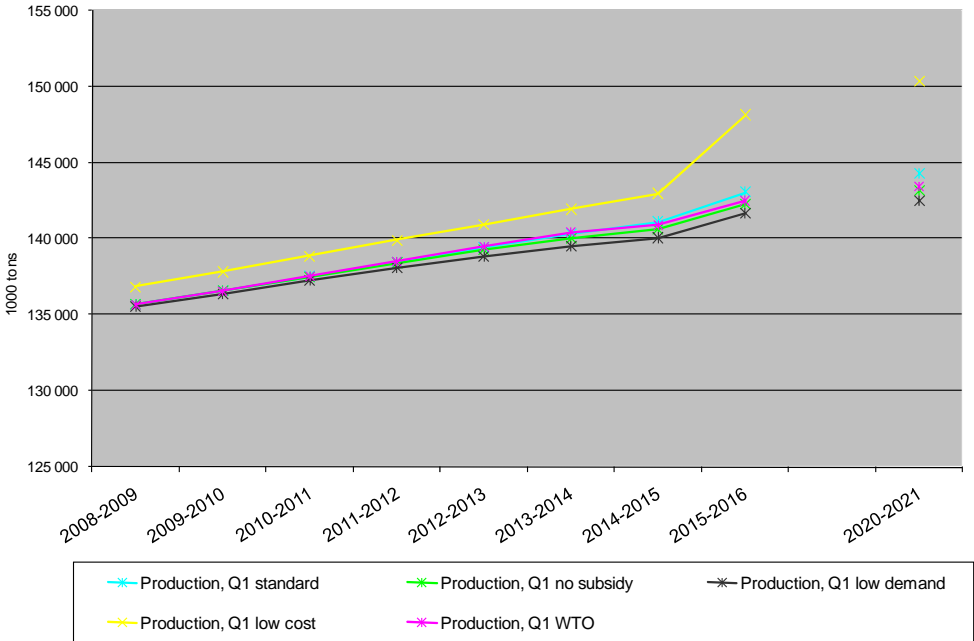

Graph 49 : Scenario Q1. Analysis of sensitivity. Change in EU27 milk price.

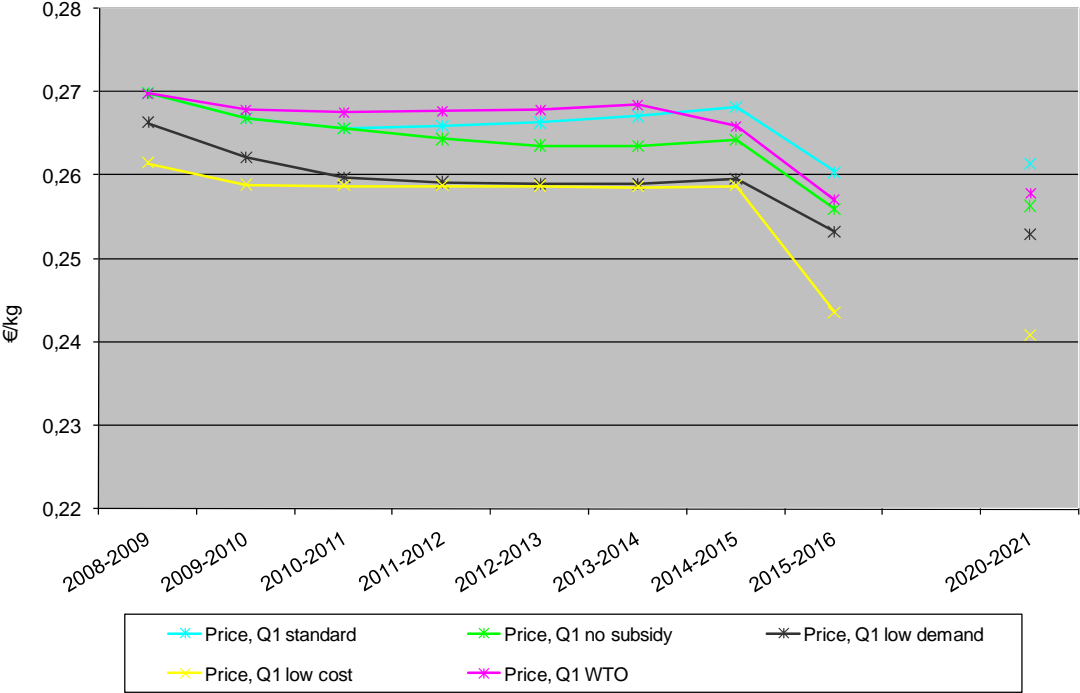

In the following table, we provide for each EU country the level of production in the standard case and in the 'low cost' case. We provide this information first for year 2008-09 that is before starting the 'soft landing' and in 2015-16 that is after removing the quota. In 2008-09, the production in EU15 member states is identical in the two cases except for UK and Sweden. In these two countries, in the standard case we assume that their observed underproduction was structural and reveals the absence of quota rents. On the contrary in the 'Low Cost' case, this assumption is no longer used and we use as marginal cost at the quota level the variable costs in these countries. Then rather than under-producing these two countries produce their quota. In EU10 member states, production in Hungary decreases as there is a very small difference of marginal costs between the two cases. The lower milk price in 'low cost' variant explains the decrease in production. For Bulgaria and Romania we have very limited information and we have not assumed the same marginal cost in the two cases explaining why their production decreases.

Table 31 : Milk collected production in sensitivities Q1 standard and Q1 low cost

	2008			2015		
	Q1 standard	Q1 low cost	Change	Q1 standard	Q1 low cost	Change
Belgium+Lux	3 347	3 347	0.0%	3 671	3 817	4.0%
Denmark	4 522	4 522	0.0%	4 740	4 954	4.5%
Germany	27 165	27 165	0.0%	28 440	29 545	3.9%
Greece	760	760	0.0%	783	825	5.3%
Spain	5 966	5 966	0.0%	6 621	6 711	1.4%
France	23 357	23 357	0.0%	24 607	25 650	4.2%
Ireland	5 277	5 277	0.0%	5 748	5 999	4.4%
Italy	10 776	10 776	0.0%	11 387	11 988	5.3%
Netherlands	10 892	10 892	0.0%	12 710	12 911	1.6%
Austria	2 679	2 679	0.0%	2 923	2 926	0.1%
Portugal	1 913	1 913	0.0%	1 898	2 082	9.7%
Finland	2 436	2 436	0.0%	2 751	2 707	-1.6%
Sweden	3 104	3 325	7.1%	3 133	3 330	6.3%
UK	13 746	14 434	5.0%	13 574	14 165	4.4%
Czech Republic	2 706	2 735	1.1%	2 700	2 719	0.7%
Hungary	1 760	1 751	-0.6%	1 922	1 892	-1.6%
Poland	8 991	9 122	1.5%	9 081	9 459	4.2%
AC7	4 182	4 317	3.2%	4 216	4 353	3.2%
Bulgaria	861	849	-1.5%	874	852	-2.5%
Romania	1 251	1 242	-0.7%	1 280	1 245	-2.7%
EU27	135 694	136 867	0.9%	143 059	148 129	3.5%

The differences in milk production and price obviously induce (or come from) differences in dairy products production or prices. The five following graphs provide the differences in butter production and price, SMP production and price and finally cheese production.

It is interesting to note that the butter production significantly increases in the 'low cost' case. On the contrary, the butter price is not affected since in this scenario, it is possible to use export subsidies to maintain the domestic butter price. This increase in production is mainly exported on world markets thanks to the use of export subsidies (and in a lower extent through some domestic subsidized consumption). This variant shows that removing quota while maintaining export subsidies could lead to a costly situation for the taxpayer. In our simulation the cost for the taxpayer is larger than 600 million euro while it is about 140 million euro in the standard case. Note also, that if the butter price could drop under the intervention price, the decrease in milk price would be larger (the increase in milk production would be lowered).

Graph 50: Scenario Q1. Analysis of sensitivity. Change in EU27 butter production.

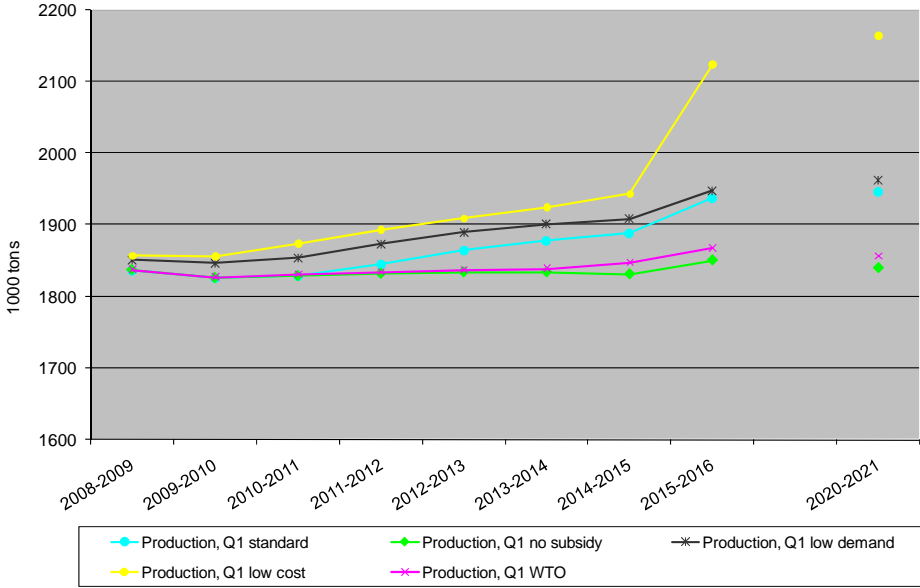

Graph 51: Scenario Q1. Analysis of sensitivity. Change in EU27 butter price.

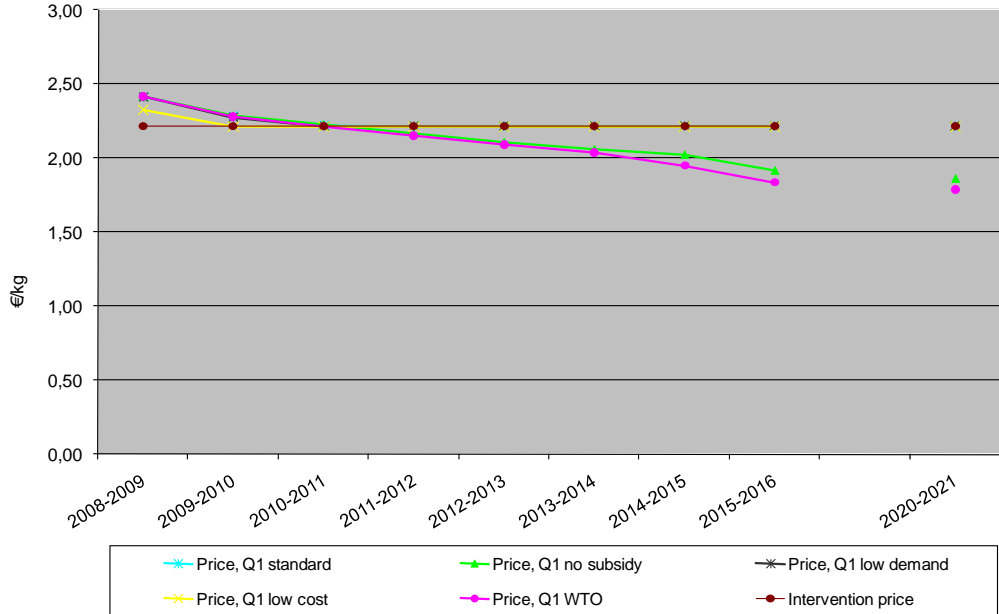

As compared to the butter case, for SMP price is more sensitive to the assumptions than butter price. This is because there is a floor price for butter while it is not the case (in practice) for SMP. SMP prices can thus vary in a larger extent.

Graph 52: Scenario Q1. Analysis of sensitivity. Change in EU27 SMP production.

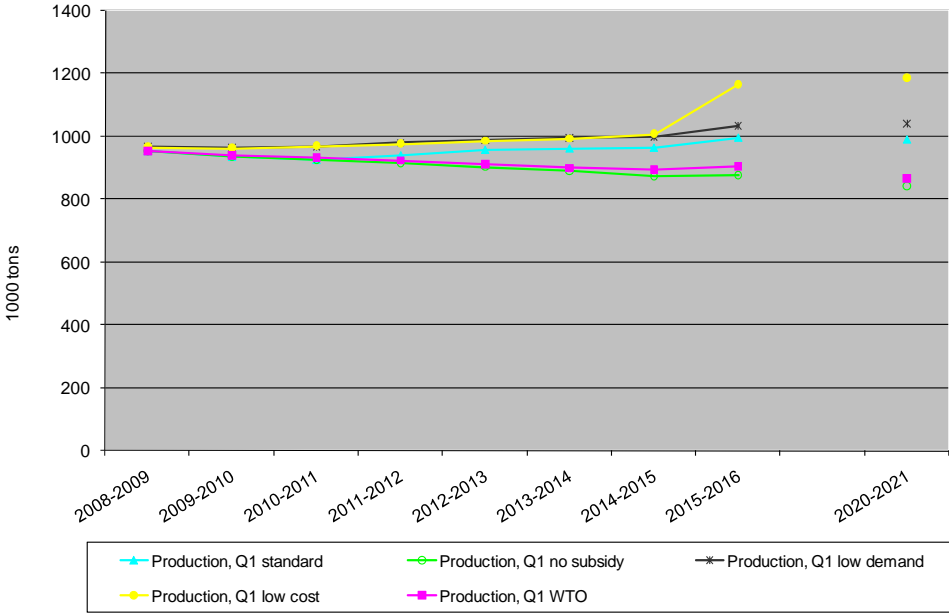

Graph 53: Scenario Q1. Analysis of sensitivity. Change in EU27 SMP price.

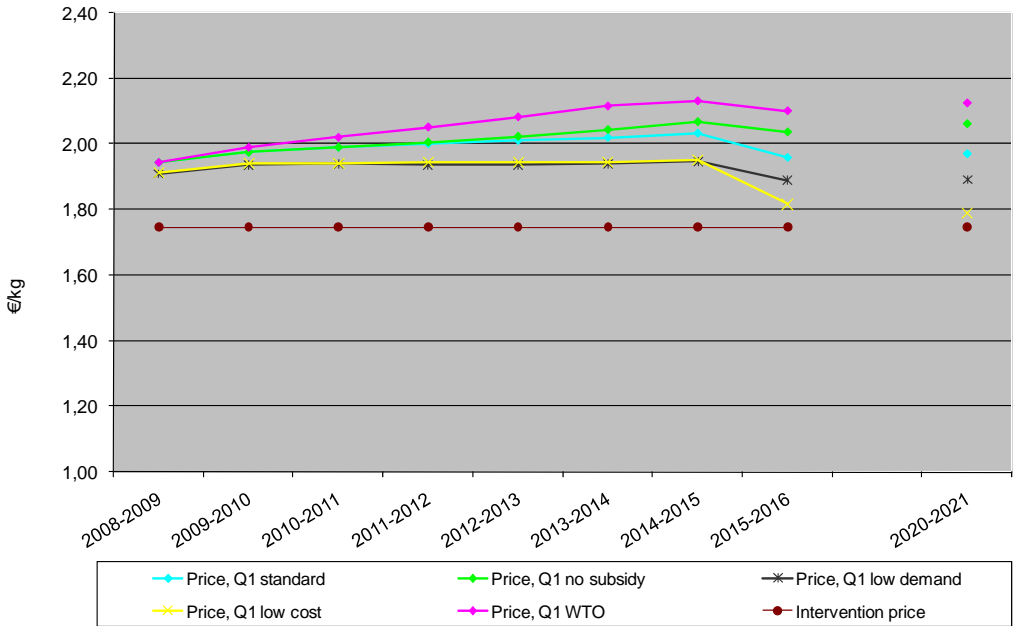

Cheese markets are mainly influenced by the domestic demand. Then, in the low demand variant, the production of cheese is significantly reduced while in all other cases differences are not large.

Graph 54: Scenario Q1. Analysis of sensitivity. Change in EU27 cheese production.

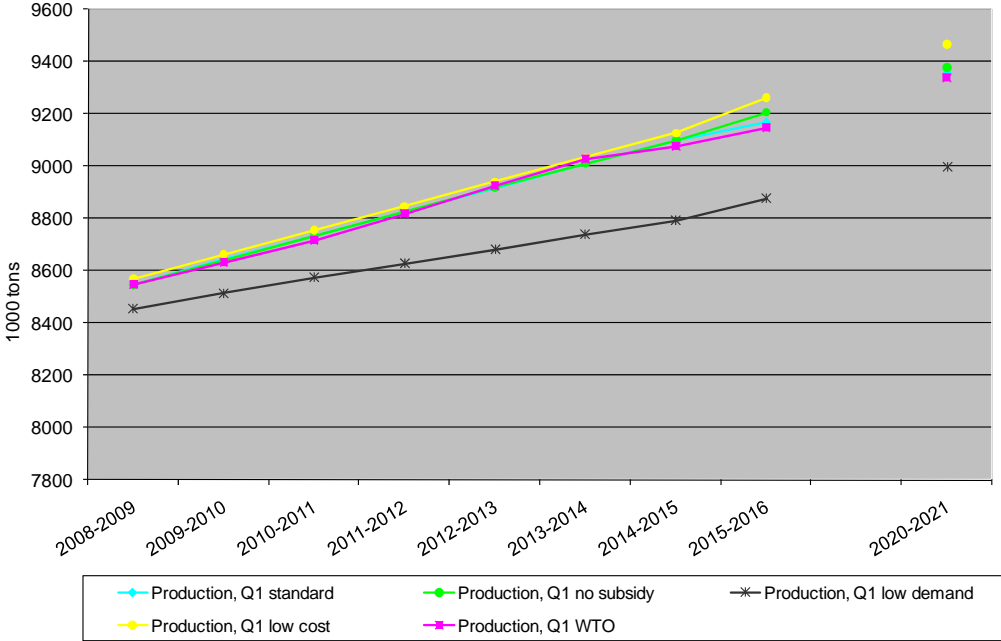

2.4.2 Analysis of sensitivity: Scenarios Q2, QR-09 and QR-15

As shown on the two following graphs, the sensitivity analysis for scenario Q2 is very similar to the one presented for scenario Q1. Thus, we do not comment anymore the results. The same remark applies to the other two cases. Thus, we will present a summary table to conclude this section on sensitivity analysis.

Graph 55 : Scenario Q2. Analysis of sensitivity. Change in EU27 milk collected production.

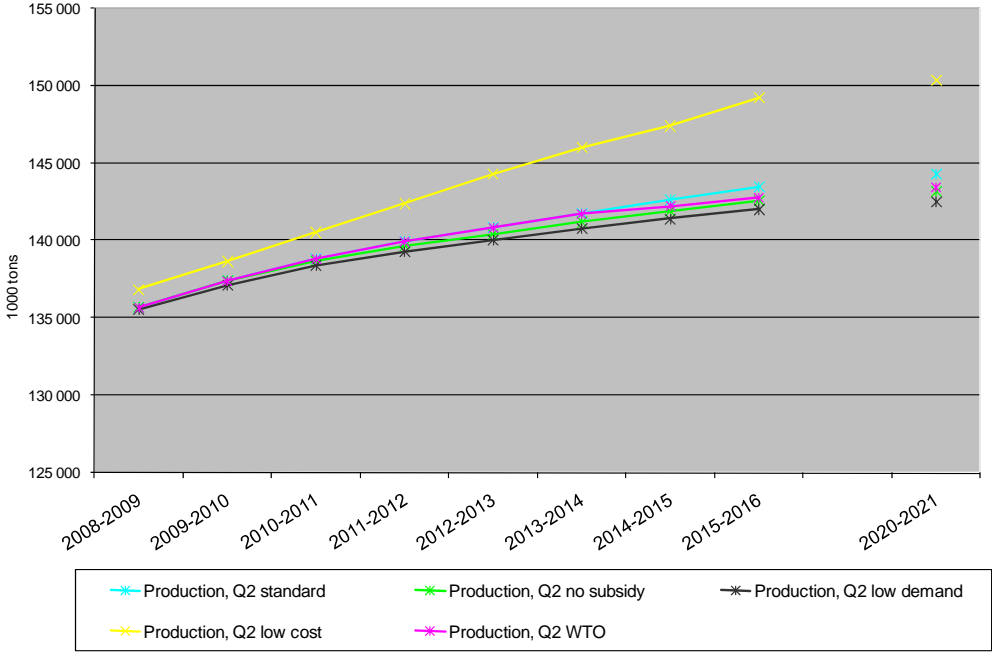

Graph 56 : Scenario Q2. Analysis of sensitivity. Change in EU27 raw milk price.

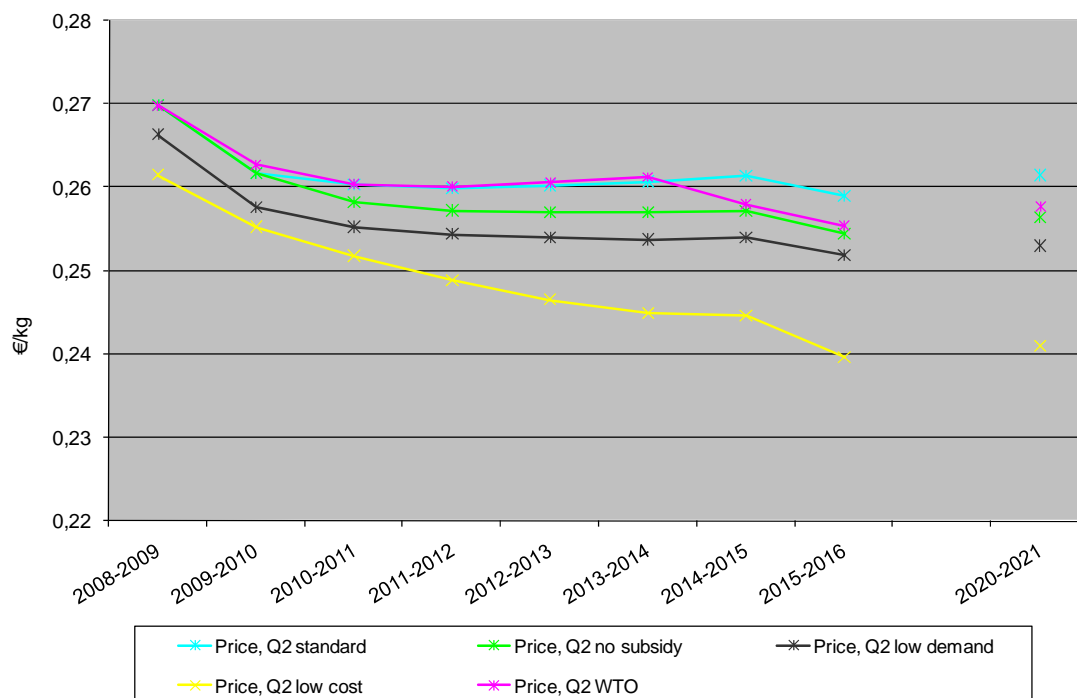

Table 32: Synthesis of the sensitivity analysis on milk price and production

	2013-14		2015-16	
	Milk price (%)	Milk production (%)	Milk price (%)	Milk production (%)
Q1				
No Subsidy	-1,4%	-0,2%	-1,7%	-0,6%
Low Demand	-3,0%	-0,6%	-2,8%	-1,0%
Low Marginal Cost	-3,2%	1,2%	-6,5%	3,5%
WTO	0,5%	0,1%	-1,3%	-0,4%
Q2				
No Subsidy	-1,5%	-0,4%	-1,8%	-0,6%
Low Demand	-2,7%	-0,7%	-2,8%	-1,0%
Low Marginal Cost	-6,1%	3,0%	-7,5%	4,0%
WTO	0,2%	0,0%	-1,4%	-0,4%
QR-09				
No Subsidy	-3,7%	-1,3%	-4,1%	-1,6%
Low Demand	-2,3%	-0,8%	-2,7%	-1,0%
Low Marginal Cost	-7,6%	4,8%	-8,3%	4,2%
WTO	-0,4%	-0,2%	-1,4%	-0,5%
QR-15				
No Subsidy	0%	0%	-1,8%	-0,4%
Low Demand	-3,3%	-0,2%	-3,2%	-0,9%
Low Marginal Cost	-2,2%	0,7%	-6,4%	3,2%
WTO	1,9%	0,1%	-1,1%	-0,3%

In 2015-16, there is almost no difference in the results for the different scenarios. The changes are lower for QR-15 (as explained before this is because the adjustment of production to quota removal is not achieved for this scenario while it is for the other ones) and larger for QR-09 as on the contrary all adjustments to the absence of quota are achieved.

In 2013-14, in some cases we have some differences in the sensitivity of the results from one scenario to the other. Results in Q2 are more sensitive than those in Q1. This is because in Q2 the production adjusts to the new conditions in a larger extent. Then for example, in the low marginal cost the increase in production is larger (as compared to the standard case) and therefore the milk price decrease is larger too.

These possibilities of adaptation of production also explain the results in QR-09 and QR-15. In QR-09, there is no longer quota in 2013-14. Then, in the low marginal cost case, the production fully adjust to the new conditions while in the other scenarios the adjustment is not complete as for some countries the quota limits a full adjustment (compare QR-09 with QR-15).

3 Lowering the super-levy: a qualitative assessment

As explained in Box 2 (p. 30), lowering the super-levy is an alternative solution for soft landing. This will be the case as soon as it becomes profitable for some producers to produce above their quota and to pay the super-levy (denoted by SL in the following). Denoting by P the farm milk price, these producers will get a per-unit price P for their milk production within the quota and they will get a per unit price $P-SL$ for their production above the quota. As soon as their marginal cost is lower than $P-SL$ they will have an interest to produce over their quota (and they will do so till the level of production such that the marginal cost will be equal to the $P-SL$). It should be noted that what is really important is the levy effectively paid by producers. We will come back later on this issue.

A theoretical comparison of two soft landing solutions: quota increase versus super-levy decrease

As shown in the scenario analysis, the allocation of additional quota to producers leads to an increase in production and to a decrease in the farm milk price. In the following, we assume that the super-levy is chosen such that the increase in production is identical to the one obtained by a quota increase. Then the market price effect is identical in both cases.²⁵ The comparative analysis needs to distinguish two different situations. In the first one, the quotas are not tradable. In the second one, they are tradable.

Case 1: quotas are not tradable

The non-tradable quota situation is depicted in Figure 9a. The first difference between the 'increase quota' and 'super-levy lowering' solutions is related to producers' and taxpayers' surplus. In the 'increase quota' case, producers do not pay to get the additional quota (at least in the way they are attributed in the dairy sector). On the contrary, in the super-levy case, producers have to pay to the

²⁵ To simplify the analysis, we ignore the price effect. The comparison between the two situations is not changed.

taxpayer for the right to produce in excess of the quota. There is thus a transfer from producers to taxpayers which amounts to $SL_1 \cdot \Delta Q$ with ΔQ the increase in production.

A second difference is related to who will produce the additional quantity. In the 'increase quota' case, all producers can increase their production and will do so as long as their marginal cost is lower than P . In the super-levy case, it is only the most efficient producers who will produce (i.e. those with marginal costs lower than $P - SL_1$) that is the producers who are the most likely to continue to produce after quota removal. Then this way to allow for an increase in production seems superior as it implicitly targets on the most efficient producers.

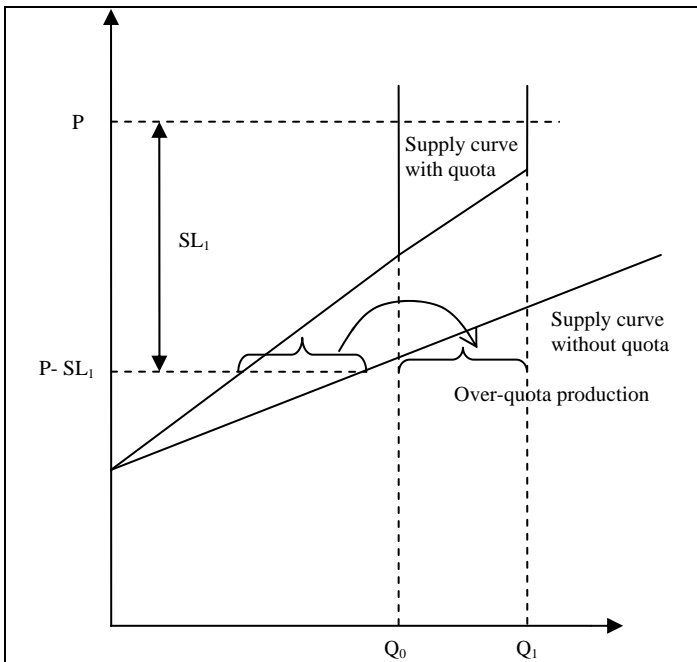

Figure 9a: Non tradable quota. The impact of a superlevy reduction

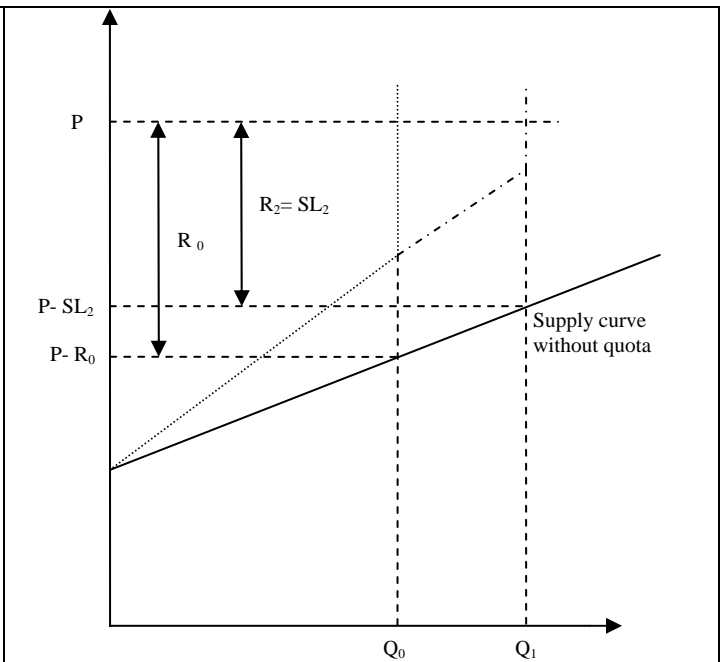

Figure 9b: Tradable quota. The impact of a superlevy reduction

Case 2: quotas are tradable

The situation for tradable quota is depicted on Figure 9b. When quota can be freely traded among producers, the difference in the allocation of production among farmers disappears. Thus, in the 'increase quota', all producers receive additional quota but through the market for quota the less efficient producers have interest to sell their additional quota to the most efficient producers (on Figure 9b, the lease price of the quota is R_0 with the initial endowment of quota and is R_2 with the additional quota endowment).

Therefore, when quotas are tradable, the difference between the 'increase quota' case and the 'decrease super-levy' case is in the repartition of surplus between agents. At the aggregate level (that is for the producers as a whole), in the super-levy case, producers have to pay to the taxpayer for the right to produce in excess of the quota. Likewise in Case 1 there is thus a transfer from producers to taxpayers which, in this case amounts to $SL_2 \cdot \Delta Q$ with ΔQ the increase in production. Note however,

that compared to a situation where quota are not tradable (Case 1), the super-levy needed to induce a given increase in production is lower ($SL_2 < SL_1$).

However, when quota are tradable, in the 'increase quota' case there are some internal transfers of surplus from the most efficient producers (who buy some quota) to the less efficient ones (who sell some quota). Rather than paying the taxpayer, the efficient producers now pay their less efficient colleague farmers. In the super-levy case, only efficient producers pay to the taxpayer. The super-levy they have to pay is SL_2 which is equal to the lease price of the quota (R_2).

Some practical issues to implement the super-levy

As explained above, what is important is the effective levy the producers pay. In practice this strongly depends on the way the super-levy is implemented. As explained in the first part of the report, there are large differences among countries. The differences rely on the way unused quota from under-shooters is accounted for the payment of super-levy by the over-shooters. To anticipate the impact of lowering the super-levy on the production thus need to analyze in detail how the system is implemented in the different EU countries, including constraints on quota tradability.

The second difficulty to anticipate the impact of decreasing the super-levy is relative to the lack of information about the distribution of marginal costs among producers.

Thus the super-levy option is an interesting one, but anticipating the level where it becomes an effective way to allow for an increase in production is not easy. However, it should be reminded that to be an effective option, the value of the levy needs to be lower than the lease price of the quota (in countries where quota trade is allowed). Otherwise, it is a better option for efficient producers to lease quota on the market rather than to pay the levy for their over-quota production.

4 Concluding remarks

This section highlights some selected key findings, a number of qualifications and some points for discussion.

Key findings:

From the numerous results generated from the model simulations some main patterns can be observed.

- The impact assessments of scenario Q1 and Q2 demonstrate that a gradual phasing out of quotas leads to a smoother price adjustment to a without quota situation, enabling a soft landing for producers, in comparison to an abrupt removal of quotas;
- All scenarios rely on the support mechanism for butter: in general butter prices quickly hit the intervention price floor. Or, alternatively, the EU is not competitive and will remain reliant on export subsidies for butter. In the absence of production limiting quotas (and unchanged market policy measures), such a situation would lead to increased market interference by market regulators through subsidies;
- As compared to the gradual phasing out quota scenarios (Q1 and Q2), the quota removal scenarios not only generate a relatively big shock, but they also imply a more uneven development over member states. From an efficiency viewpoint the one shot-removal scenarios benefit low cost (competitive) producers. The costs of adjustment, such as exit costs, might be higher, however;

- As compared to the Baseline, all scenarios considered significantly affect the production of industrial products: as compared to the baseline where their production tends to decrease, this trend is reversed into an increase. Although not unchanged, the production patterns of products for final consumption (e.g. fresh dairy, liquid milk, cheese, etc.) show a more stable behavior;
- Since demand for dairy products in the EU is inelastic and the obtained price declines are limited, the increases in EU dairy production lead to significant increases in EU exports. Where the considered scenarios generally improve the EU's market presence through the use of export refunds (at least for butter), they also affect the world market price level: the induced price declines on world markets are of the same order of magnitude than the price declines observed within the EU market;
- The different scenarios induce a significant shift of surplus from producers to consumers. The producers (farmers) lose and the consumers gain. Producers lose as negative price effects are significantly more important than positive quantity effects. As compared to the Luxemburg agreement the taxpayer is only marginally affected. The processors benefit from the new situation as they can expand their production. On the whole there is no significant net welfare gain to the EU because part of the potential gain is 'exported' to foreign consumers who benefit from lower dairy product prices.
- The decrease in producers' surplus integrates the decrease in quota rents as well as price effects. Because quota, which corresponds to a 'right to produce', is an asset, the decrease in quota rent will affect the value of this asset. This means that part of the loss of surplus will be borne by owners of quota who are not always the producers. The relative share of loss that is borne by dairy producers rather than owners is variable among countries. It depends, among other elements, how the market for quota is organized, if any.
- The low marginal cost (or high quota rent) sensitivity analysis shows that assumptions about quota rents significantly matter to assess the final market impacts. Due to the inelastic demand it is not so much quantities, but rather prices which will be affected. Related to this also producer returns (e.g. producers' surplus) will be affected.
- The demand-related sensitivity analysis (no subsidy, low demand and WTO) move in line and show a rather modest impact on prices as well as quantities as compared to the standard scenarios.

Qualifications and discussion

The model analysis assumes a rather quick adjustment of the dairy sector to a new equilibrium situation; this holds in particular for the processing side and consumer markets. In reality this adjustment process might be more sluggish (in particular relevant for the one shot-quota removal scenarios). Whereas the primary milk supply part takes into account some dynamics (adjustments in herd stocks, impact of lagged prices) it remains difficult to foresee how expectations and producer behaviour will exactly adjust in the light of such a structural brake in the policy regime. For example, in several countries anticipatory declines on quota rents were observed (which might reflect adjusted expectations rather than reflecting structural changes in marginal costs of production).

Whereas the production expansion impacts found are in general rather limited, for some countries larger expansion effects were found. It is our impression that the production increases are feasible within the current system of environmental regulations, but it was beyond the scope of this analysis to do a detailed check.

Whereas the supply model accounts for the role of quota rents, it should be noted that in the longer run also rents on other fixed factors (notably land) might adjust due to the policy changes. In essence the current analysis is a partial equilibrium analysis, although one that takes into account multiple market impacts (e.g. beef prices, feed prices).

The modelling analysis focuses on 'normalized' conditions. This implies that incidental fluctuations both at the supply side and the demand side are not accounted for by definition. However, such changes (e.g. the recent drought in Australia) might influence the actually observed market situations quite significantly (In particular in the very short run, when possibilities for adjustment are limited, prices may peak under such circumstances, although at the yearly level used as the basis for our model price swings are usually less pronounced) . Nevertheless, in terms of our model, with its inelastic behaviour of supply and demand, 'small' shocks might induce strong price fluctuations. However, at the same time this underscores the need to, in an analytical sense, try to separate such impacts from the impacts generated by policy changes. In general, the policy scenario's simulated, with finally the full removal of the quota, will make the EU dairy sector more subject to world price fluctuations and volatility. In absolute values the results of this study are obviously sensitive to the conditions on the world market (as shown by the actual 2007 situation of markets). However in relative values, the results are much less sensitive as the mechanisms depicted will remain.